



# Ampt i20 String Optimizer

System voltages: 750 - 1500V

Output currents: 16 - 20A

## Installation Manual

57070012-1 M  
©2022 Ampt LLC

Copyright 2022 Ampt LLC. All rights reserved. No part of this document may be reproduced, retransmitted, or copied in any form without the expressed and written permission of Ampt LLC.

This document contains information needed to install and commission an Ampt optimizer (including Smart String Technology® optimizers, String Stretch® optimizers, Ampt Mode® optimizers, String View® optimizers, V-match® optimizers, and Direct-to-Battery® optimizers) within a photovoltaic (PV) installation. The result? Energy realized®.

All Ampt trademarks are the property of Ampt, LLC. All trademarks are recognized even if they are not marked separately. Visit [www.ampt.com/trademarks](http://www.ampt.com/trademarks) for a list of Ampt trademarks. Any unauthorized use of Ampt trademarks is prohibited. All other trademarks are the property of their respective owners.

U.S. and international patents apply to this product. For details visit: [www.ampt.com/patents](http://www.ampt.com/patents).

## Read This First

To help avoid problems during the system installation, familiarize yourself in advance with the installation process by reading this entire document before starting the installation.



Risk of electric shock, do not remove covers. No user serviceable parts inside. Refer servicing to qualified service personnel. When the photovoltaic array is exposed to light, it supplies a dc voltage to this equipment.



Le risqué de décharge électirque n'enlèvent pas la couverture. Aucunes pieces utiles d'utilisateur à l'intérieur. Référez-vous l'entretien au personnel de service qualifiè. Quand la range photovoltaïque est exposée à la lumière. Il fournit une tension CC à cet équipement.



Hot surfaces – to reduce the risk of burns – do not touch.



Les surfaces chaudes - pour réduire le risque de brûlures - ne se touchent pas.

## Important Safety Instructions

This manual contains important instructions for Ampt optimizers that shall be followed during installation and maintenance. The optimizer has been designed and tested according to international safety requirements, but requires certain precautions are observed when installing and/or operating the optimizer. To reduce the risk of personal injury and to ensure the safe installation and operation of the optimizer, please be sure you carefully read and follow all instructions and safety messages in this manual.

SAVE THESE INSTRUCTIONS

## Safety Message Types

The following messaging is used to identify a hazard to equipment or personnel:



### **DANGER**

Indicates a hazardous situation which, if not avoided, will result in death or serious injury.



### **WARNING**

Indicates a hazardous situation which, if not avoided, could result in death or serious injury.



### **CAUTION**

Indicates a hazardous situation which, if not avoided, could result in minor or moderate injury.

### ***NOTICE***

Indicates information considered important but not hazard, or personal injury, related - for example, property damage.

## General Safety

Installation and maintenance should be performed only by qualified persons. Installers and maintenance personnel assume the risk of all injury that might occur during installation or maintenance including, without limitation, the risk of electric shock. Follow your safety procedures and protocols.

All electrical installations must be done in accordance with the local and National Electrical Code ANSI/NFPA 70; Canadian Electrical Code, Part I; or the applicable standards, codes, and regulations for your region.

Failure to follow this manual will void warranty.

The Ampt product contains no user-serviceable parts. All repairs and maintenance should be handled in accordance with the instructions and terms contained in the product warranty.

Before installing or using the Ampt optimizer, read all instructions and safety messages on the optimizer and in this manual. Follow the safety precautions for this product as well as the other components in the PV system.

PV modules produce electrical energy when exposed to light and thus can create an electrical shock hazard. Wiring of the PV modules should only be performed by qualified personnel.

### **NOTICE**

Opening the optimizers, performing any other service to the optimizers, or using the optimizers in a way that is not specified by the manufacturer voids warranty.

## Disclaimer of Liability

Ampt makes no representations, expressed or implied, that with respect to this documentation or any of the equipment and/or software it may describe, including (with no limitation) any implied warranties of utility, merchantability, or fitness for any particular purpose. All such warranties are expressly disclaimed. Ampt shall not be liable for any indirect, incidental, or consequential damages under any circumstances. (The exclusion of implied warranties may not apply in all cases under some statutes, and thus the above exclusion may not apply.)

The following information is subject to change without notice, even though every attempt has been made to make this document complete, accurate and up to date. Readers are cautioned, however, that Ampt reserves the right to make changes without notice and shall not be responsible for any damages, including indirect, incidental or consequential damages, caused by reliance on the material presented, including, but not limited to, omissions, typographical errors, arithmetical errors or listing errors in the content material.

### **WARNING**

Any use of the Ampt String Optimizer that is not expressly authorized in this manual or associated documentation is expressly prohibited by Ampt. Ampt disclaims any responsibility or liability for such prohibited use.

## Optimizers Covered in this Manual

This manual applies to the i20 String Optimizer, which includes all applicable system voltages as well as any valid combination of open-circuit output voltage and maximum output current options.

The i20 String Optimizer replaces the legacy naming conventions listed below.

Vxxx-20-xx

V1500-20, V1500-20-20, V1500-20-16

V1000-20, V1000-20-20, V1000-20-16

V750-20, V750-20-20, V750-20-16

### About Optimizer Models (SKUs)

Optimizer models use the format below:

**Vxxx-iy-zz**

Where, xxx = Open-circuit output voltage option

iy = String Optimizer name

zz = Maximum output current option

For example, V1350-i20-16 is an i20 String Optimizer with an open-circuit output voltage of 1350 volts and a maximum output current of 16 amps. The specifications for this unit can be found in the i20 datasheet for 1500-volt systems.

## Before You Begin

### Handling and Storage

- Store optimizers in a clean, dry area that is protected from weather exposure and pooling water (-30 to 80°C. Relative humidity < 80%).

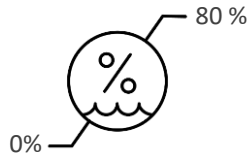
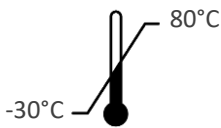

- Leave the product in its original packing box until you are ready to install.
- Do NOT stack pallets.
- Do NOT lift, carry, or otherwise handle the optimizers by their connectors.

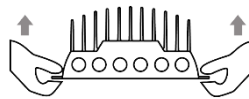
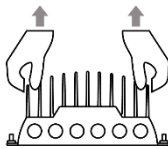
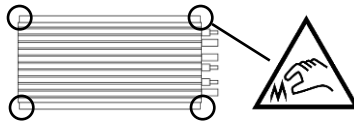

- Leave connector caps in place until the optimizers are ready to be connected to protect the optimizer from water and debris ingress.
- Do NOT transport optimizers that are removed from original packaging. If the original packaging is no longer available, use a similar box to protect the connectors and heat sink fins.

### Quick Reference and Best Practices

#### NOTICE

The last page of this manual has a quick reference sheet for making electrical connections as well as a list of best practices. *After reading this manual*, the quick reference sheet can be used on the job site to ensure the correct electrical connection order and to avoid damaging the device.

### Using Optional Wireless Communication

#### NOTICE

If the String Optimizers are being used with optional wireless communication, then refer to the Ampt Communication Unit (Ampt CU) manual for important requirements related to the String Optimizer installation.





# Table of Contents

<b>Read This First</b> .....	<b>2</b>
Important Safety Instructions .....	3
Safety Message Types .....	3
General Safety .....	4
Disclaimer of Liability .....	5
<b>Optimizers Covered in this Manual</b> .....	<b>6</b>
About Optimizer Models (SKUs) .....	6
<b>Before You Begin</b> .....	<b>7</b>
Handling and Storage .....	7
Quick Reference and Best Practices .....	7
Using Optional Wireless Communication .....	7
<b>Chapter 1: Product Overview</b> .....	<b>11</b>
<b>Dimensional Drawings</b> .....	<b>12</b>
<b>Physical Overview</b> .....	<b>13</b>
<b>Bar Code Label</b> .....	<b>13</b>
<b>Specifications</b> .....	<b>14</b>
<b>Chapter 2: Understanding Electrical Configurations</b> .....	<b>15</b>
<b>PV Array Configurations</b> .....	<b>15</b>
Ungrounded PV Arrays .....	15
Grounded PV Arrays (positive or negative) .....	15
<b>Acceptable Input Configurations</b> .....	<b>16</b>
Optimizer Input Requirements .....	16
Acceptable Input Configurations Between Parallel Optimizers .....	17
<b>Fuses</b> .....	<b>17</b>
Understanding Maximum Output Current and Fuse Sizing .....	17
Input Fuses .....	17
<b>DC-coupled Storage</b> .....	<b>18</b>
<b>Inter-row Shading Wiring Example</b> .....	<b>18</b>
<b>Chapter 3: Installing the String Optimizer</b> .....	<b>19</b>
<b>Getting Started</b> .....	<b>19</b>
Parts and Tools Needed .....	19
<b>Mounting and Grounding the String Optimizer</b> .....	<b>20</b>
Mounting Considerations .....	20
Steps .....	21
<b>Understanding Connector Polarity</b> .....	<b>22</b>

<b>Making Electrical Connections .....</b>	<b>23</b>
Connection/Disconnection Order Matters .....	24
Connecting the Inputs .....	24
Connecting the Output .....	27
<b>Disconnecting the Output and Inputs .....</b>	<b>28</b>
Parts and Tools Needed .....	28
Steps.....	29
<b>Appendix.....</b>	<b>31</b>
<b>Compliance.....</b>	<b>31</b>
Model Numbering System .....	31
Markings.....	31
FCC Compliance.....	32
RSS-GEN .....	32
Avis IC.....	32
RSS-GEN .....	32
<b>Reference: Electrical Connection Order.....</b>	<b>33</b>
Handling and Storage Best Practices.....	34
Mounting Best Practices .....	34
Electrical Connections Best Practices.....	34
Ampt Support Contacts.....	34

# Chapter 1: Product Overview

Ampt String Optimizers are DC/DC converters with multiple features that lower the cost and improve the performance of new and existing PV systems and energy storage systems.

- **Dual MPPT per optimizer** - Ampt String Optimizers put maximum power point tracking on each of its two input strings of PV modules. This mitigates or eliminates mismatch losses to deliver more energy under changing environmental and system conditions over the lifetime of the power plant.
- **High Fixed-Voltage Bus (HFVB)** – Ampt’s advanced DC power management technology allows for HFVB system designs which turn the variable voltage of the PV array into a fixed and predictable DC bus voltage to achieve system-level economic advantages.
- **Ampt Mode®** – Inverters in Ampt Mode® operate in a fixed or narrow input voltage range that is closer to the maximum system voltage. This allows the inverter to deliver a higher AC output voltage at the same current which raises the inverter’s rated output power up to 50% to lower the inverter’s cost per watt.
- **String Stretch®** – Ampt’s patented String Stretch® technology puts voltage and current limits on the output of each optimizer which doubles the number of modules per string and allows for smaller conductor sizing per kilowatt delivered to save up to 25% on electrical BOS costs.
- **Direct-to-Converter™** – For DC-coupled energy storage systems with Ampt, the DC bus operates at a fixed voltage that is always higher than the battery voltage which eliminates 50% of the battery converters’ power circuitry while increasing its power density to lower the converter’s cost per watt.
- **High DC/AC** – This Ampt feature allows PV system designers to achieve optimal DC:AC ratios (up to 3:1); expand the DC power on existing systems without replacing inverters, combiners, or cables; optimize inverter utilization; and increase storage durations – all at a lower capex.
- **V-match®** – The output of our optimizers matches the DC bus voltage set by the inverter or battery converter while delivering full available power from the PV modules. This uniquely allows PV arrays with Ampt to automatically adapt to legacy or future power equipment to repower existing systems, upgrade inverters, mix new and legacy PV modules, deploy optimized DC-coupled storage systems, and other applications.
- **Full Tracker Fit** – Ampt optimizers overcome string-voltage sizing constraints to fit more modules on a tracker than systems without Ampt. Increasing the number of modules per tracker allows system designers to fully use the tracker’s mechanical capacity and lower tracker cost per watt.
- **Wireless Communication** – Ampt String Optimizers incorporate optional wireless communication to provide string-level data that is highly accurate, synchronous, and scalable to improve O&M, as well as enhanced controls for storage applications.

For more information on Ampt’s product features and applications, visit [www.ampt.com](http://www.ampt.com).

## Dimensional Drawings

The dimensions for the String Optimizer shown below are in millimeters and inches.

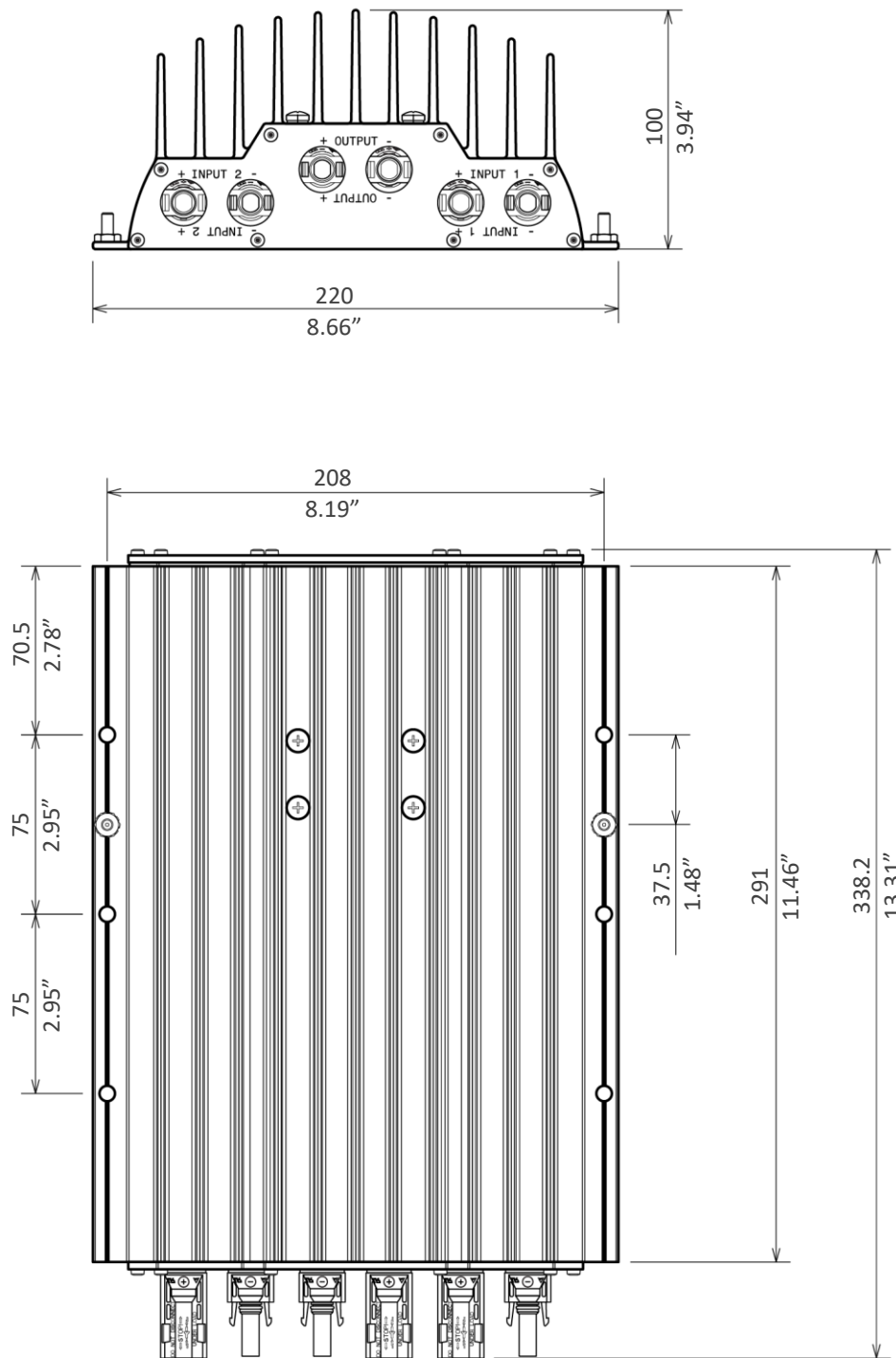

Figure 1: Dimensional drawings

## Physical Overview

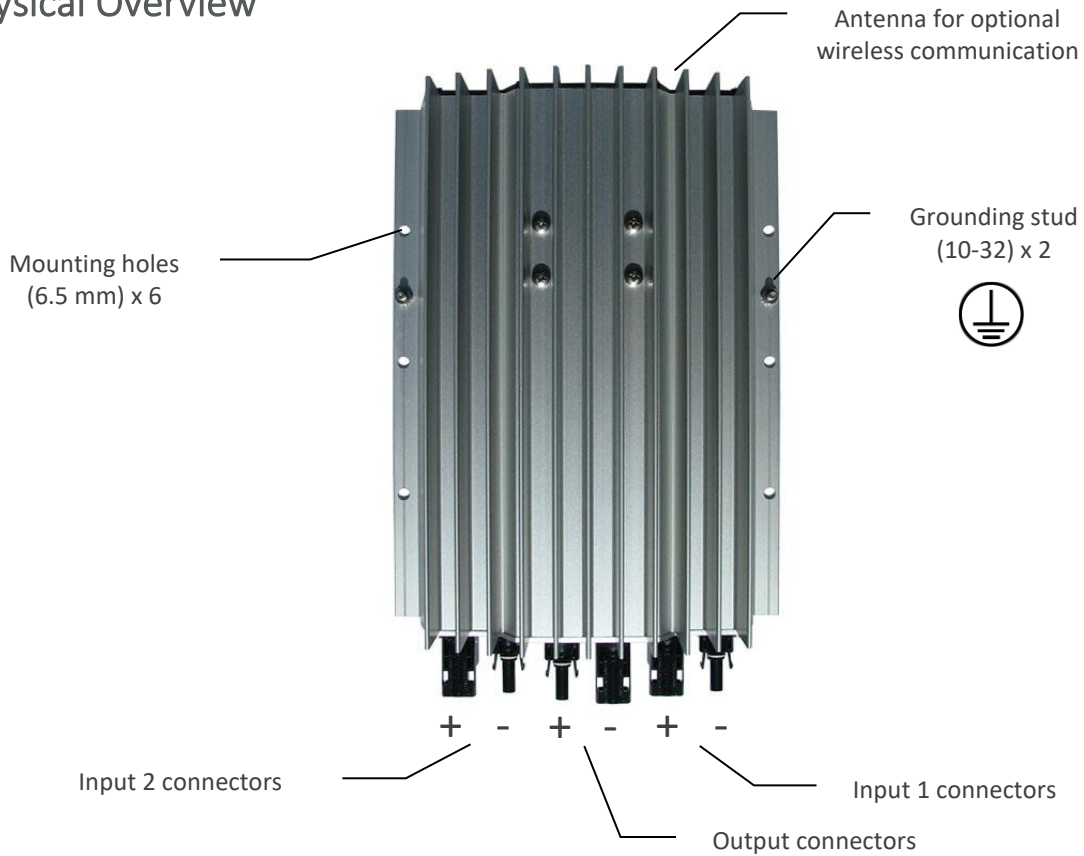

Figure 2: Physical overview of the string optimizer

## Bar Code Label

The image below shows the bar code label with model and serial numbers. Do NOT remove this label. Removing any label from the optimizer voids warranty.



Figure 3: Bar code tag with the model and serial numbers

## Specifications

The following specifications apply to all i20 String Optimizers. Electrical specifications vary by model and can be found on the optimizer product label and/or datasheet.

Mechanical	
Input & output connector	Amphenol H4
Dimensions	13.31" x 8.66" x 3.94" (338 mm x 220 mm x 100 mm)
Weight	11.6 lbs. (5.3 kg)
Ambient temperature operating range	-40 °F to +122 °F (-40 °C to +50 °C)
Cooling	Convection
Environmental	
Environmental category	Outdoor
Pollution degree	2
Maximum operating altitude	9843 ft (3000 m)
Overvoltage category	OVII
Ingress protection	IP66 / 4X
General	
Compliance	ETL to UL 1741; IEC 61000-6-1, 61000-6-3, 62109; CE; Giteki 2-1-19; FCC Part 15, class A

# Chapter 2:

## Understanding Electrical Configurations

This chapter explains the installation requirements and considerations that ensure proper operation of the String Optimizer.

### NOTICE

The inputs of the optimizer are not intended for connection to a battery or any other type of DC source except PV modules.

## PV Array Configurations

String Optimizers can be installed in ungrounded and resistively grounded PV systems.

### Ungrounded PV Arrays

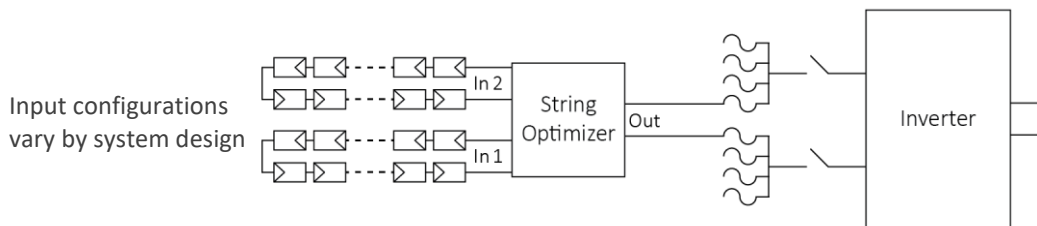

Figure 4: Electrical connections for an ungrounded PV array

### Grounded PV Arrays (positive or negative)

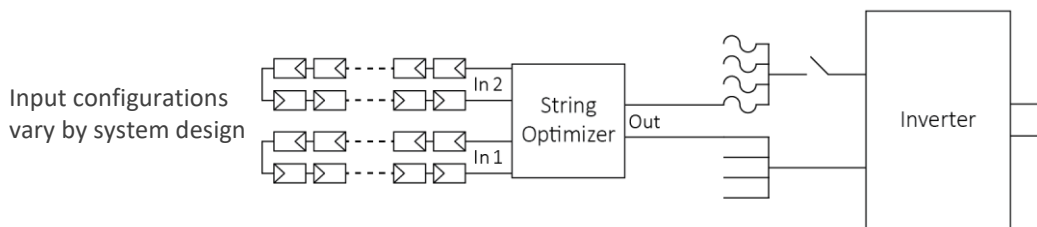

Figure 5: Electrical connections for a grounded PV array

## Acceptable Input Configurations

Each input of the optimizer can have multiple PV strings of the same length in parallel. Each PV string in parallel, on a given input, should have the same open-circuit voltage ( $V_{oc-cold}$ ).

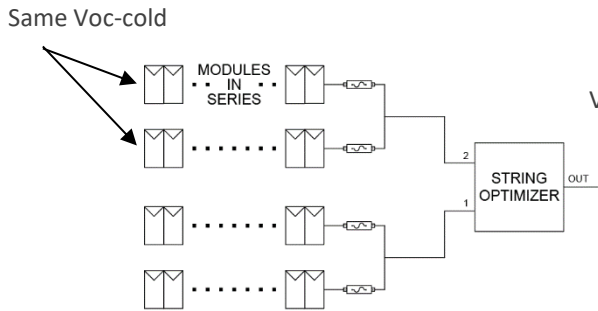

Figure 6: Example - Two strings in parallel on each input

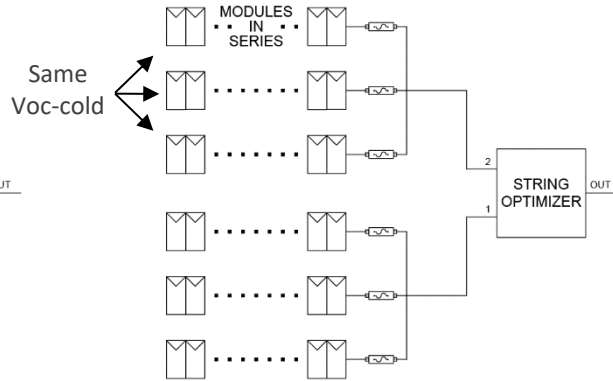

Figure 7: Example - Three strings in parallel on each input

When the number of modules on each input is not the same, the input with the highest power should be connected to input 1.

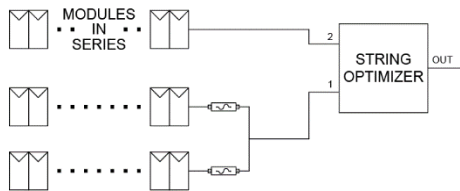

Figure 8: Strings with the highest power should be connected to Input 1

Note:

For inputs with a single string, like Input 2 shown here, a fuse may or may not be needed to protect the modules in case of an array fault. See [Fuses](#) section for more information.

## Optimizer Input Requirements

It is common for inputs 1 and 2 to have the same number of modules (i.e.  $I_{n1} = I_{n2}$ ). However, if the number of modules between inputs is different, the following conditions must be met for the optimizer to operate at MPP.

$$V_{oc-cold-in1} \geq V_{oc-cold-in2}$$

$$V_{out}/2 < V_{mpp-in1} < V_{out}$$

$$V_{oc-cold-in1} \leq \text{Maximum voltage per optimizer input}$$

$$V_{out}/2 < V_{mpp-in2} < V_{out}$$

$$V_{oc-cold-in1} \leq \text{Inverter maximum input voltage}$$

$$0.5 \times P_{in1} < P_{in2} < P_{in1}$$



## Acceptable Input Configurations Between Parallel Optimizers

The number of modules on each input between parallel optimizers can vary within an array so long as they meet the criteria described in the [Acceptable Input Configurations](#) section.

## Fuses

### CAUTION

Over-current protection devices and conductors shall be sized in accordance with the National Electrical Code (ANSI/NFPA 70); Canadian Electrical Code, Part I; or the applicable standards, codes, and regulations for your region.

## Understanding Maximum Output Current and Fuse Sizing

The recommended PV system design ensures that the DC bus voltage, which is set by the inverter, is always greater than the optimizer input voltages. For these systems, the maximum output current will be the *Maximum output current* listed on the optimizer's datasheet.

This design allows the output current limit of the Ampt String Optimizer to eliminate the need for the 1.25 multiplication factor for over-sun conditions when calculating ampacity. The 1.25 multiplier for continuous use is still required.

Optimizer Max Output Current (A)	Minimum Fuse Size (A)
16	20
20	25

For other system designs where the DC bus voltage can be less than the voltage on either optimizer input, the potential maximum output current will either be the *Maximum output current* listed on the optimizer's datasheet or the maximum input current – whichever is greater. If the maximum output current is the one listed on the optimizer datasheet, use the table above. Otherwise, use your standard fuse sizing method including margins for both over-sun and continuous use.

## Input Fuses

For single PV strings on an optimizer input, an input fuse may be required to protect the modules in the event of an array fault when the maximum series fuse rating for the PV modules is less than the output fuse rating. For parallel PV strings on an optimizer input, always use fuses to protect the PV modules.

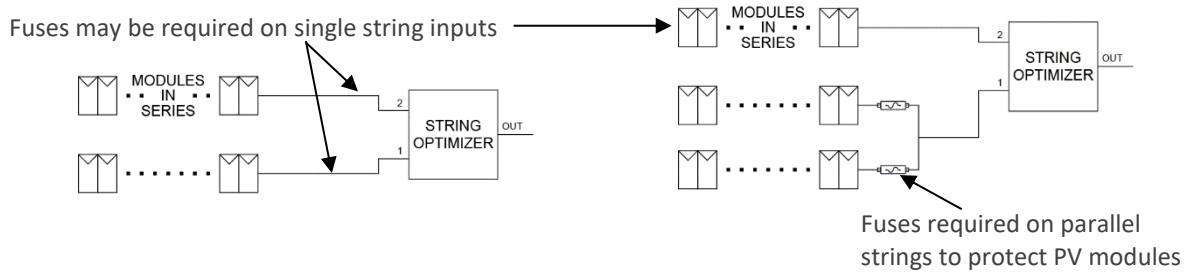

Figure 9: Single PV strings may, and parallel PV strings must, have input fuses to protect the PV modules.

When input fuses are needed, use the appropriate calculations for your jurisdiction to size fuses to ensure that your module strings are protected according to the maximum series fuse rating on the datasheet for the PV modules.

## DC-coupled Storage

When used in DC-coupled storage applications, the optimizer does not function as a blocking diode.

## Inter-row Shading Wiring Example

When inter-row shading is expected, the best practice is to wire the modules on the two inputs of the Ampt String Optimizer to be on the same row as shown below.

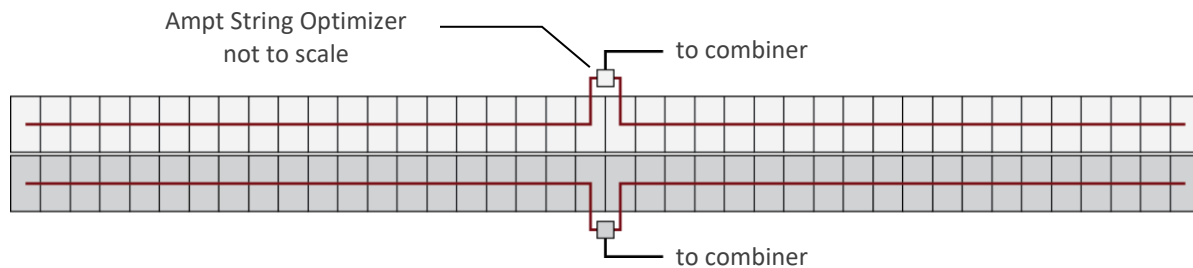

Figure 10: Wiring example when inter-row shading is expected

# Chapter 3: Installing the String Optimizer

## Getting Started

This chapter addresses the proper mounting and installation of the Ampt String Optimizer. Read the entire chapter before starting the procedures and then conduct each task in the order given.

### Parts and Tools Needed

- The mounting hardware varies by the type of PV module mounting rail.
- Voltmeter (rated for the PV system’s maximum system voltage) with DC current clamp.
- Amphenol Sealing Caps – H4 or UTX



H4 Sealing Cap (for female)  
H4PF



UTX Sealing Cap (for female)  
UTXF



H4 Sealing Cap (for male)  
H4PM



UTX Sealing Cap (for male)  
UTXM

# Mounting and Grounding the String Optimizer

## Mounting Considerations

- Do NOT mount optimizers with connectors facing upwards.
- Leave space between mounted optimizers to allow for air circulation and cooling.
- Ensure sufficient spacing so that maintenance personnel can read the optimizer faceplate, safety icons, serial number, model number, and bar code label.
- Keep optimizer free from pooling water.
- Do NOT mount optimizers directly to a solar module frame.
- Do NOT drill into optimizer frame to expand mounting holes.
- Secure the optimizer by using at least two of the 6.5 mm mounting holes.
- If using wireless communication:
  - Optimizers have an antenna on the opposite side of the connectors. Keep the antenna clear from obstructions - including cables, mounting hardware, and PV modules, to allow radio waves to and from the Ampt Communication Unit (CU).
  - Line of sight from the optimizer to the Ampt CU is recommended.
  - See the [Ampt CU manual](#) for more information.
- When possible, mount optimizer in a location protected from the elements.
- Leave connector sealing caps in place until the optimizers are ready to be connected to the PV string.

### **WARNING**

Read the warning statements below:

Installation and maintenance should be performed only by qualified persons. Installers and maintenance personnel assume the risk of all injury that might occur during installation or maintenance including, without limitation, the risk of electric shock. Follow your safety procedures and protocols.

All electrical installations must be done in accordance with the local and National Electrical Code ANSI/NFPA 70; Canadian Electrical Code, Part I; or the applicable standards, codes, and regulations for your region.

The Ampt optimizer is to be installed so that it is not expected to be contacted by persons.

### **CAUTION**

Keep connectors dry and clean. Do not install Ampt String Optimizers in a location where they might be immersed in water.

## NOTICE

Read the notice statements below:

Leave the product in its original packing box until you are ready to install.

Leave connector sealing caps in place until the optimizers are ready to be connected to the PV string. The plugs protect the optimizer from water and debris ingress.

Do NOT lift, carry, or otherwise handle the optimizers by their connectors.

Do NOT transport optimizers that are removed from packaging. If the original packaging is no longer available, use a similar box to protect the connectors and heat sink fins.

## Steps

1. Read all warning, caution, and notice statements for this section.
2. Mount the String Optimizer following the [Mounting Considerations](#) section.
3. Ground the String Optimizer according to your local codes. Use one of the two grounding studs provided on the optimizer, a listed bonding washer, or another method as required. Optimizer coating is 4 mil (0.1 mm).
4. Verify that the optimizer is adequately grounded using continuity tester.

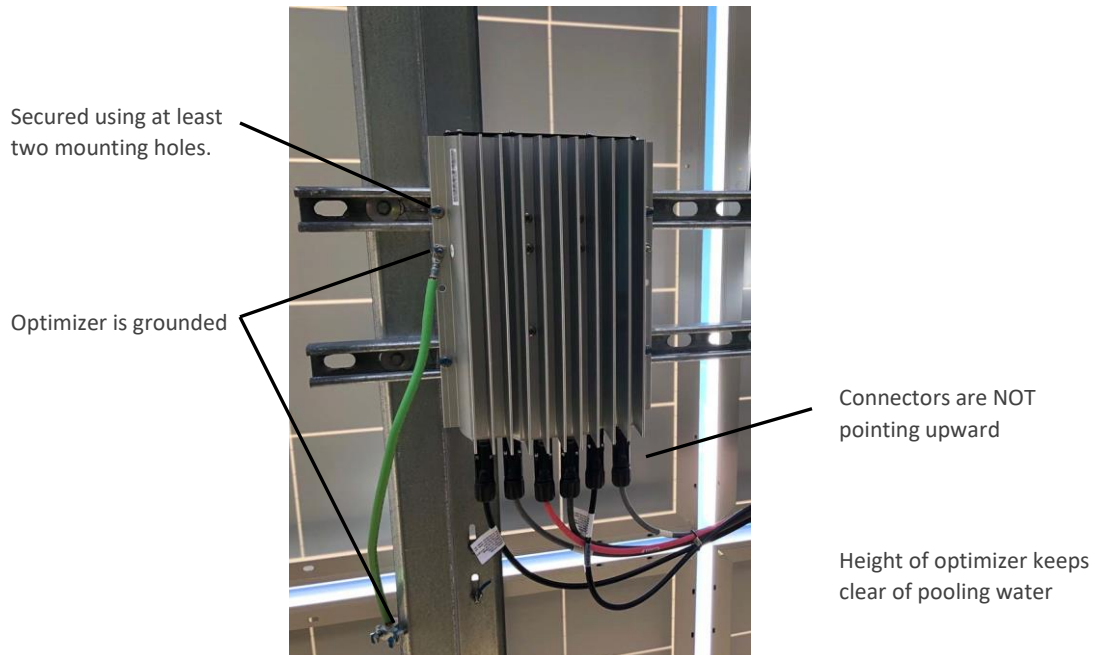

Figure 11: Example of optimizer mounted and grounded.

## Understanding Connector Polarity

Always use the polarity markings on the faceplate instead of the polarity markings on the connectors.

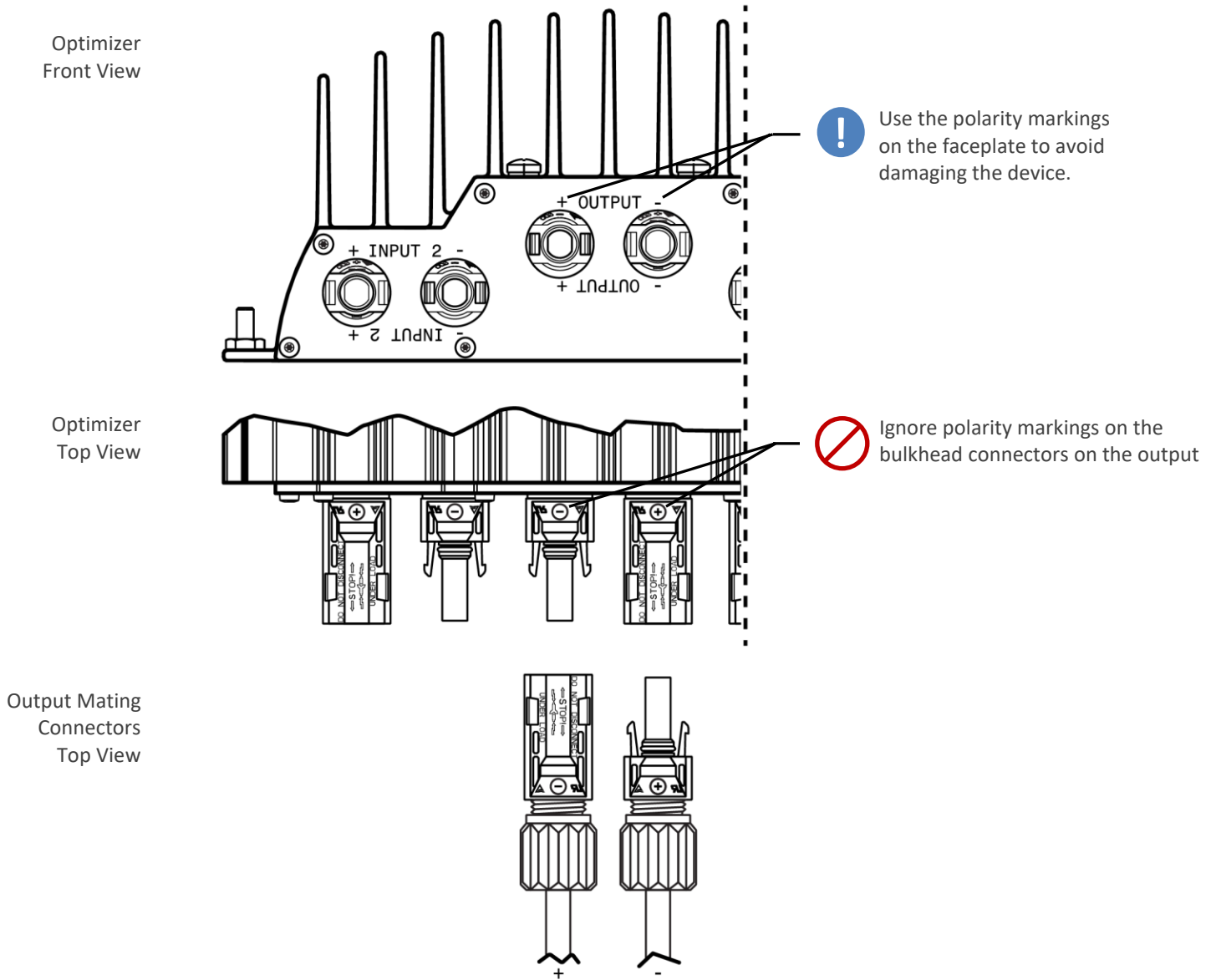

Figure 12: Output connector polarity

## Making Electrical Connections

### **WARNING**

Read the warning statements below:

Installation and maintenance should be performed only by qualified persons. Installers and maintenance personnel assume the risk of all injury that might occur during installation or maintenance including, without limitation, the risk of electric shock. Follow your safety procedures and protocols.

Do not make or break connections under load.

Ensure that there are no parallel connections to the string while series connections are being made.

Voltage may be present on the output terminals when an input terminal is connected.

Voltage builds as modules are connected in series.

### **CAUTION**

Read the caution statements below:

To reduce the risk of fire, connect the outputs of the Ampt equipment only to conductors with sufficient ampacity based on the maximum output fault current (maximum optimizer output current) for the chosen optimizer. Over-current protection devices and conductors shall be sized in accordance with the National Electrical Code (ANSI/NFPA 70); Canadian Electrical Code, Part I; or the applicable standards, codes, and regulations for your region.

Over current protection is required for the DC output circuit in the installation.

Ampt recommends that a disconnect switch be included in the installation for the DC output.

Do not put stress on the optimizer connectors at any time. The cable management method must prevent tension on each connector and movement of the connecting wires at all times. Tracker installations must avoid tension on the connectors throughout its rotation.

### **NOTICE**

Read the notice statements below:

Failure to follow these instructions will void warranty.

Failure to follow the prescribed connection and disconnection order can result in damage to the device.

Follow these instructions to avoid damaging the device. Follow polarity markings on the optimizer faceplate. Do not cross wire inputs or output.

Use only Amphenol H4 mating connectors.

Per Canadian Electrical Code, the installer is required to mark the device with the following wording or equivalent, located on or adjacent to each wiring compartment giving access to high voltage circuits, only if actually connected to high voltage in the installation:

DANGER — HIGH VOLTAGE  
or  
DANGER XXX V  
where XXX is replaced by the rated voltage.

## Connection/Disconnection Order Matters

Follow the proper connection/disconnection order in the instructions to avoid damaging the device.

## Connecting the Inputs

1. Read all warning, caution, and notice statements for this section.
2. Make sure that the unit is properly mounted and grounded.
3. Make sure the strings of PV modules that will be connected to the inputs of the optimizer meet the acceptable input criteria, fusing, and other requirements outlined in Chapter 2.
4. For optimizer inputs with strings in parallel
  - a. Follow your safety procedures and protocols to prepare each set of PV strings for each optimizer input.
    - i. Connect the PV modules in series for each string.
    - ii. Use an appropriately rated multimeter to verify the voltage and polarity of each PV string before connecting in parallel.



5. Follow your safety procedures and protocols and use an appropriately rated multimeter to measure the voltage and verify the polarity for the string(s) of modules being connected to Input 1.

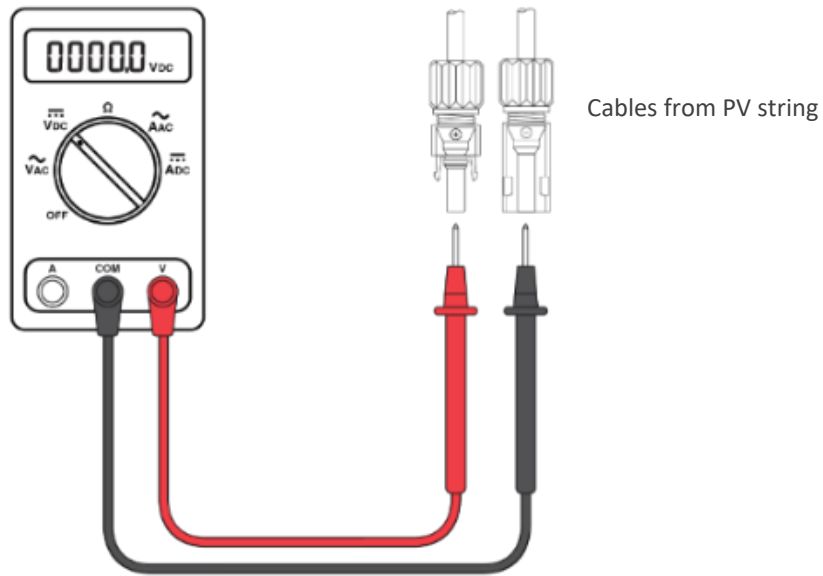

Figure 13: Check the polarity and gender for PV string

6. Connect the series of modules for Input 1 to the String Optimizer. Ensure that the locking mechanisms on the connectors are fully engaged.

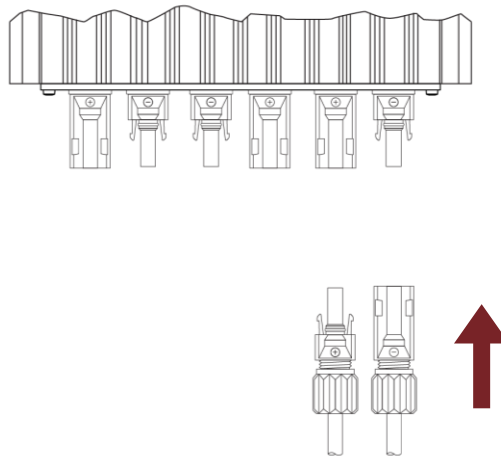

Figure 14: Connecting Input 1

7. Follow your procedures and safety protocols to measure the voltage and verify the polarity for the string of modules being connected to Input 2. See [Figure 13](#).

- Connect the series of modules for Input 2 to the String Optimizer. Ensure that the locking mechanisms on the connectors are fully engaged.

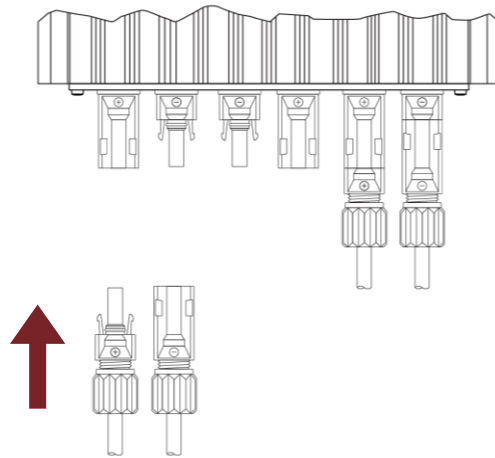

Figure 15: Connecting Input 2

- Follow your safety procedures and protocols to measure the output voltage of the String Optimizer. It should be equal to the maximum value of the Output Voltage Range on the product label (+/- 15 volts). If it is not, replace the unit.

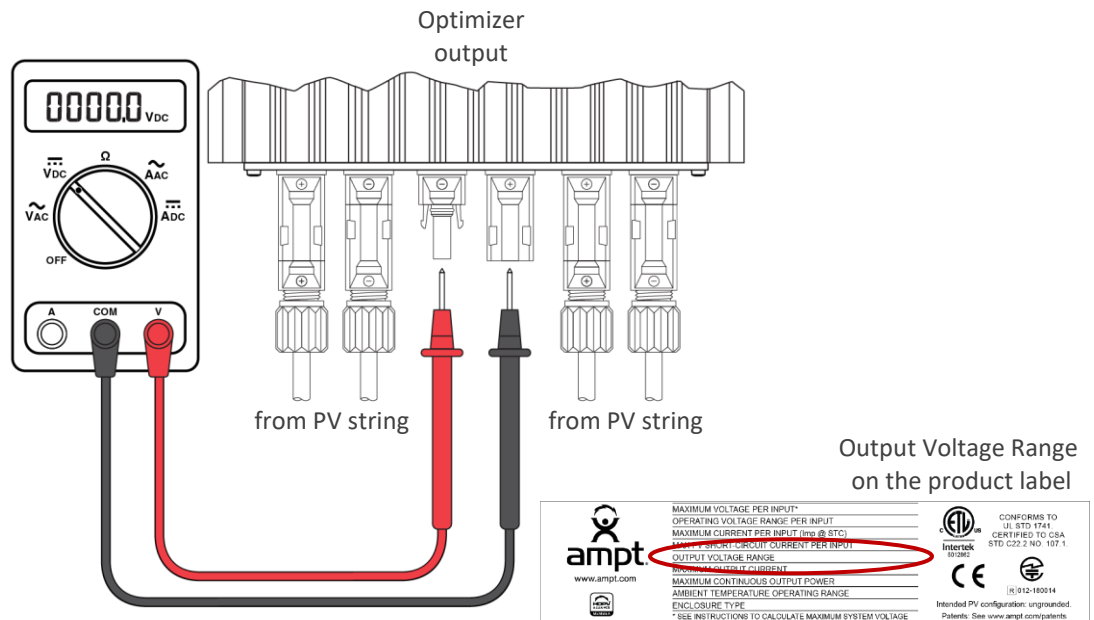

Figure 16: Verify proper installation

- If you are connecting the output now, then proceed to the next section. Otherwise, use sealing caps to protect the connectors until the output is connected.

## Connecting the Output

1. Read all warning, caution, and notice statements for this section.
2. Make sure you have completed all the steps in the
3. Connecting the Inputs section
4. Follow your safety procedures and protocols to ensure the output cables are appropriately terminated and not under load.
5. If the output cable is already energized (not isolated), verify that the optimizer output voltage and output cable share the same potential and polarity.
6. Connect the appropriate cables to the output of the String Optimizer.

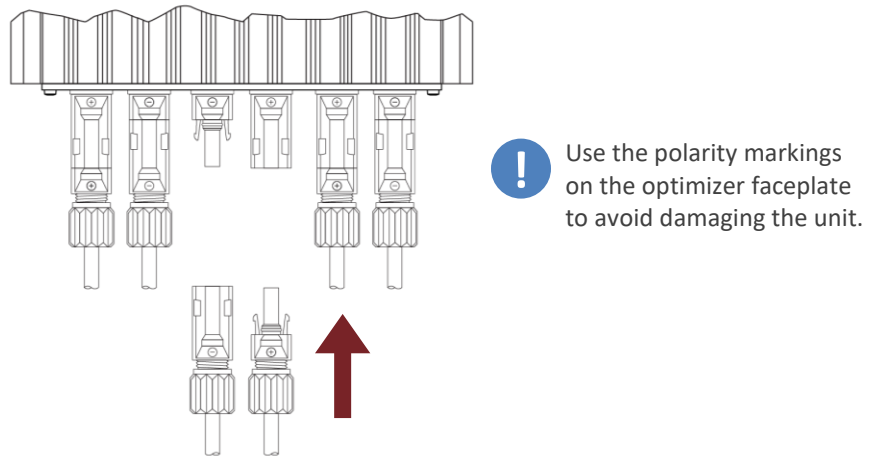

Figure 17: Connecting the output connectors

7. Ensure that the locking mechanisms on all connectors are fully engaged.
8. Manage wires to prevent lateral strain on connectors and avoid movement of the connecting wires at all times. Pay special attention when in-line fuses are used and/or when mounted on a tracker.

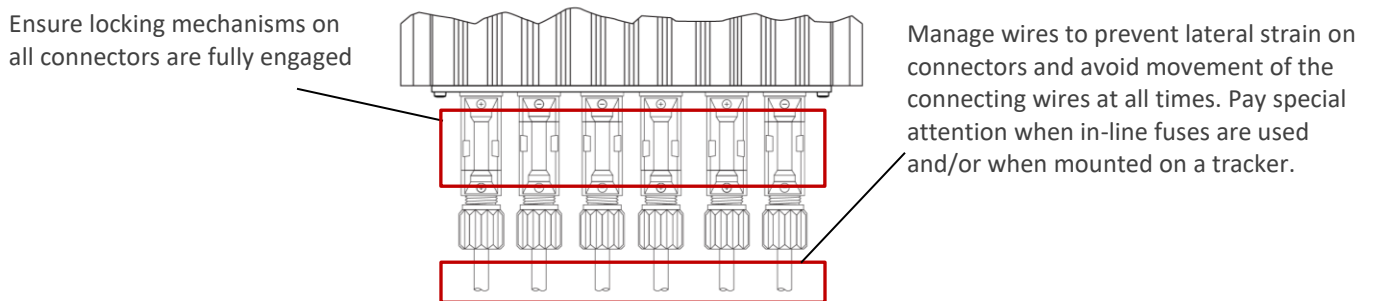

Figure 18: Verify that the connectors are fully engaged and manage cables to prevent tension on the connectors

## Disconnecting the Output and Inputs

### WARNING

Read the warning statements below:

Installation and maintenance should be performed only by qualified persons. Installers and maintenance personnel assume the risk of all injury that might occur during installation or maintenance including, without limitation, the risk of electric shock. Follow your safety procedures and protocols.

Do not perform any servicing other than that specified in these instructions.

Do not make or break connections under load.

Voltage may be present on the output terminals when an input terminal is connected.

### CAUTION

Read that caution statements below:

The Ampt product contains no user-serviceable parts. All repairs and maintenance should be handled in accordance with the instructions and terms contained in the product warranty.

The surface of the optimizer may be hot.

### **NOTICE**

Read the notice statements below:

Failure to follow these instructions will void warranty.

Failure to follow the prescribed order can result in damage to the device.

## Parts and Tools Needed

- Appropriately rated voltmeter and DC current clamp
- Amphenol sealing caps for H4 or UTX connectors
- One of the following Amphenol connector unlocking tools:



H4 Universal unlocking tool  
H4TU0000



H4 Wrench Tool  
H4TW0001



UTX Wrench Tool  
UTXTWA001

## Steps

1. Read all warning, caution, and notice statements for this section.
2. Follow your safety procedures and protocols to ensure the String Optimizer is not under load.
3. Follow your safety procedures and protocols to verify that there is zero current flowing through the optimizer circuit by using a current clamp to test each wire connected to Input 1, Input 2, and the output.
  - a. If current is detected on any of these cables, wait for zero irradiance and verify that there is zero current flowing through the optimizer circuit.

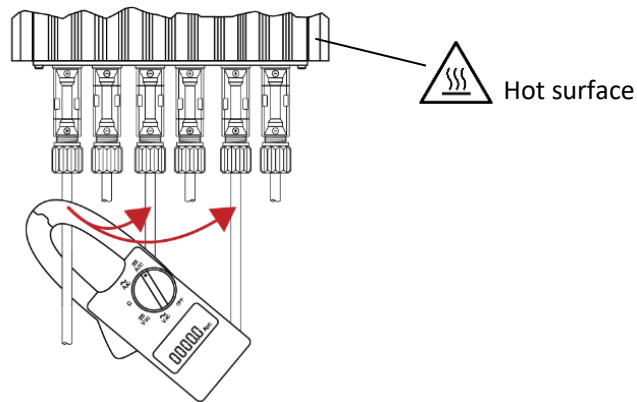

Figure 19: Verify that there is zero current flowing through the optimizer circuit

4. If no current is detected, then use the Amphenol H4 connector unlocking tool to disconnect connectors in the following order:

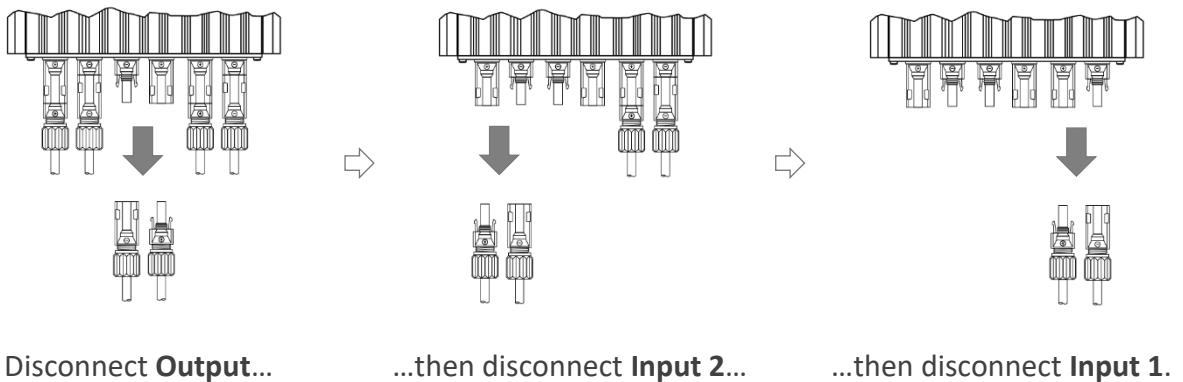

Figure 20: Disconnection order matters

5. If the PV cables will not be immediately reconnected, use sealing caps on the optimizer connectors to protect the unit from water and debris ingress



# Appendix

## Compliance

\*\*\*

The box is not meant to be user serviced or opened in any way.

\*\*\*





## Model Numbering System

The model numbers for Ampt String Optimizers are in the following format:

- 31570020-xxxx (20A models, ranging from 400 – 1500V)
- 31570021-xxxx (16A models, ranging from 400 – 1500V)
- 31570022-xxxx (12A models, ranging from 400 – 1500V)

...where xxxx equals voltage of the unit (e.g. -0750 is a V750; -1325 is V1325).

## Markings

 www.ampt.com 	MAXIMUM VOLTAGE PER INPUT*	
	OPERATING VOLTAGE RANGE PER INPUT	
	MAXIMUM CURRENT PER INPUT (Imp @ STC)	
	MAX PV SHORT-CIRCUIT CURRENT PER INPUT	
	OUTPUT VOLTAGE RANGE	
	MAXIMUM OUTPUT CURRENT	
	MAXIMUM CONTINUOUS OUTPUT POWER	
	AMBIENT TEMPERATURE OPERATING RANGE	
	ENCLOSURE TYPE	
	* SEE INSTRUCTIONS TO CALCULATE MAXIMUM SYSTEM VOLTAGE	
 CONFORMS TO UL STD 1741. CERTIFIED TO CSA STD C22.2 NO. 107.1.	 Intended PV configuration: ungrounded.	 R 012-180014
Patents: See <a href="http://www.ampt.com/patents">www.ampt.com/patents</a>		

## FCC Compliance

This device complies with part 15 of the FCC Rules. Operation is subject to the following two conditions: (1) This device may not cause harmful interference, and (2) this device must accept any interference received, including interference that may cause undesired operation.

IMPORTANT! Changes or modifications not expressly approved by Ampt, LLC could void the user's authority to operate the equipment.

Model: 1500V  
FCC ID: X3R-1500V  
IC: 8399A-1500V

\*\*\*

## RSS-GEN

This device contains license-exempt transmitter(s)/receiver(s) that comply with Innovation, Science and Economic Development Canada's license-exempt RSS(s). Operation is subject to the following two conditions:

1. This device may not cause interference.
2. This device must accept any interference, including interference that may cause undesired operation of the device.

## Avis IC

Cet appareil est conforme à la partie 15 des règles de la FCC. Son fonctionnement est soumis aux deux conditions suivantes: (1) Ce dispositif ne peut causer des interférences nuisibles, et (2) cet appareil doit accepter toute interférence reçue, y compris les interférences qui peuvent provoquer un fonctionnement indésirable.

IMPORTANT! Les changements ou modifications non expressément approuvés par Ampt, LLC pourraient annuler l'autorité de l'utilisateur à utiliser l'équipement.

Model: 1500V  
FCC ID: X3R-1500V  
IC: 8399A-1500V

\*\*\*

## RSS-GEN

L'émetteur/récepteur exempt de licence contenu dans le présent appareil est conforme aux CNR d'Innovation, Sciences et Développement économique Canada applicables aux appareils radio exempts de licence. L'exploitation est autorisée aux deux conditions suivantes:

1. L'appareil ne doit pas produire de brouillage.
2. L'appareil doit accepter tout brouillage radioélectrique subi, même si le brouillage est susceptible d'en compromettre le fonctionnement.



## Reference: Electrical Connection Order

After the installer has read the manual, this page can be used as a reference on the job site to ensure the electrical connection order and to avoid damage to the device.



These instructions are for reference only and do not replace the installation manual. See the manual for complete instructions and safety messages.



### WARNING

Read the warning statements below:

Installation and maintenance should be performed only by qualified persons. Installers and maintenance personnel assume the risk of all injury that might occur during installation or maintenance including, without limitation, the risk of electric shock. Follow your safety procedures and protocols.

Do not make or break connections under load.

Ensure that there are no parallel connections to the string while series connections are being made.

Voltage may be present on the output terminals when an input terminal is connected.

Voltage builds as modules are connected in series.

Do not put lateral strain on the optimizer connectors at any time. The cable management method must prevent strain on each connector and movement of the connecting wires at all times. Tracker installations must avoid tension on the connectors throughout its rotation.

### NOTICE

Failure to follow these instructions will void warranty.

Failure to follow the prescribed connection order can result in damage to the device.

### 1. Verify PV string voltage and polarity. Connect Input 1

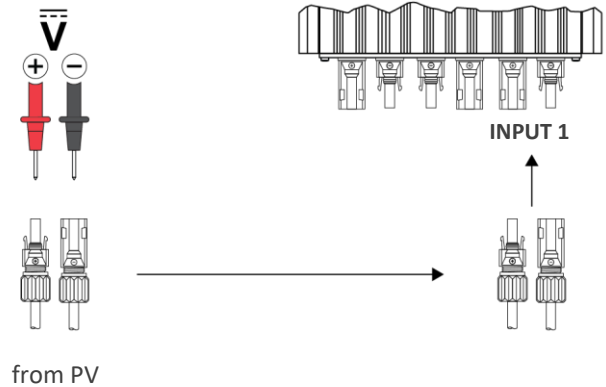

### 2. Verify PV string voltage and polarity. Connect Input 2

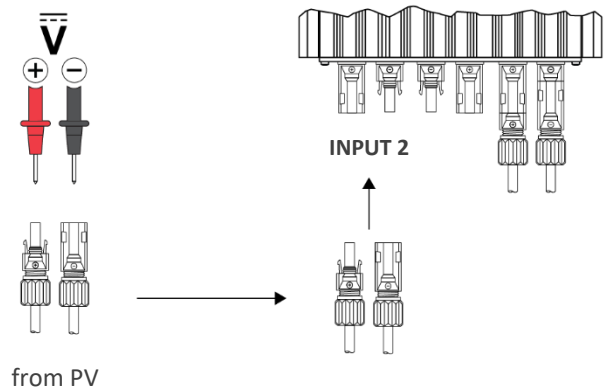

### 3. Verify output voltage. Connect Output

$V_{out}$  = maximum value of the Output Voltage Range on the label (+/-15 volts)

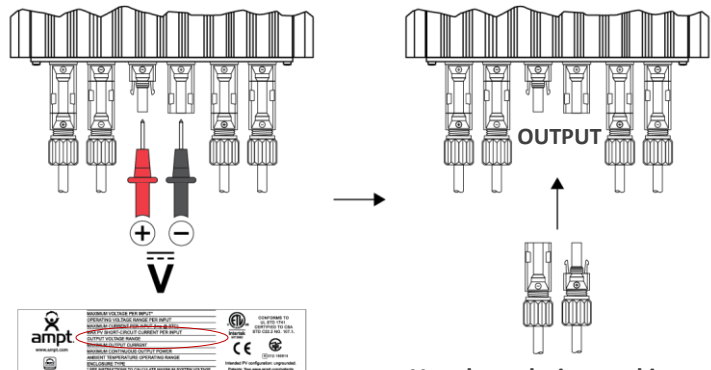

Use the polarity markings on the optimizer faceplate

Note: Disconnect in reverse order (Output, Input 2, Input 1) using an Amphenol connector unlocking tool for H4 connectors (e.g. Amphenol p/n: H4TU0000)

## Handling and Storage Best Practices

- Store optimizers in a clean, dry area that is protected from weather exposure and pooling water (-30 to 80°C. Relative humidity < 80%).
- Leave the product in its original packing box until you are ready to install.
- Do NOT stack pallets.
- Do NOT lift, carry, or otherwise handle the optimizers by their connectors.
- Leave connector caps in place until the optimizers are ready to be connected to protect the optimizer from water and debris ingress.
- Do NOT transport optimizers that are removed from original packaging. If the original packaging is no longer available, use a similar box to protect the connectors and heat sink fins.

## Mounting Best Practices

- Ground the String Optimizer according to your local codes.
- Verify that the optimizer is adequately grounded using continuity tester.
- Do NOT mount optimizers with connectors facing upwards.
- Leave space between mounted optimizers to allow for air circulation and cooling.
- Ensure sufficient spacing so that maintenance personnel can read the optimizer faceplate, safety icons, serial number, model number, and bar code label.
- Keep optimizer free from pooling water.
- Do NOT mount optimizers directly to a solar module frame.
- Do NOT drill into optimizer frame to expand mounting holes.
- Secure the optimizer by using at least two of the 6.5 mm mounting holes.
- When possible, mount optimizer in a location protected from the elements.
- If using wireless communication, keep the antenna (located on the opposite side of the connectors) clear from obstructions. Line of sight from the optimizer to the Ampt Communication Unit (CU) is recommended. See Ampt CU manual for more information.
- Leave connector sealing caps in place until the optimizers are ready to be connected to the PV string.

## Electrical Connections Best Practices

- Use only Amphenol mating connectors on input and output wires that are connected to optimizer.
- Only use Amphenol H4 crimping pliers with the appropriate crimp range on cabling and connectors.
- If an optimizer input has two or more PV strings in parallel, make parallel connections before connecting to the optimizer input.
- Do NOT cause lateral strain on the optimizer bulkhead connectors. Make sure there is enough slack on the input and output wires to avoid strain. If installed on a tracker system, keep wires free from abrasion and leave enough slack in the wires to account for tracker movement.
- Test voltage and polarity of input strings and optimizer output before connecting.
- Ensure there are no ground faults on input strings.
- Do NOT operate optimizer with only one input.
- Connect in the following order: Input 1, Input 2, Output.
- If the output cable is already energized (not isolated), verify that the optimizer output voltage and output cable share the same potential and polarity.
- Configure inverter settings appropriately according to the project design.
- Do NOT disconnect under load.
- Always use a current clamp to ensure there is no current present before disconnecting outputs/inputs.
- Disconnect in reverse order (Output, Input 2, Input 1) using an Amphenol unlocking tool for H4 connectors. (e.g. Amphenol p/n: H4TU0000)

## Ampt Support Contacts

Global	North America	Europe	Japan
support@ampt.com	+1 970.372.6951	+49 7456 20 88 42	+81.45.565.9977



