



Ampt i13.5 String Optimizer

System voltages: 600 - 1000V

Output currents: 12 – 13.5A

Installation Manual

57070009-1 R
©2022 Ampt LLC

Copyright 2022 Ampt LLC. All rights reserved. No part of this document may be reproduced, retransmitted, or copied in any form without the expressed and written permission of Ampt.

This document contains information needed to install and commission an Ampt optimizer (including Smart String Technology[®] optimizers, String Stretch[®] optimizers, Ampt Mode[®] optimizers, String View[®] optimizers, V-match[®] optimizers, and Direct-to-Battery[®] optimizers) within a photovoltaic (PV) installation. The result? Energy realized[®].

All Ampt trademarks are the property of Ampt, LLC. All trademarks are recognized even if they are not marked separately. Visit www.ampt.com/trademarks for a list of Ampt trademarks. Any unauthorized use of Ampt trademarks is prohibited. All other trademarks are the property of their respective owners.

U.S. and international patents apply to this product. For details visit: www.ampt.com/patents.

Read This First

To help avoid problems during the system installation, familiarize yourself in advance with the installation process by reading this entire document before starting the installation.



Risk of electric shock, do not remove covers. No user serviceable parts inside. Refer servicing to qualified service personnel. When the photovoltaic array is exposed to light, it supplies a dc voltage to this equipment.



Le risqué de décharge électrique n'enlèvent pas la couverture. Aucune pièces utiles d'utilisateur à l'intérieur. Référez-vous l'entretien au personnel de service qualifié. Quand la range photovoltaïque est exposée à la lumière. Il fournit une tension CC à cet équipement.



Hot surfaces – to reduce the risk of burns – do not touch.



Les surfaces chaudes - pour réduire le risque de brûlures - ne se touchent pas.

Important Safety Instructions

This manual contains important instructions for Ampt optimizers that shall be followed during installation and maintenance. The optimizer has been designed and tested according to international safety requirements, but requires certain precautions are observed when installing and/or operating the optimizer. To reduce the risk of personal injury and to ensure the safe installation and operation of the optimizer, please be sure you carefully read and follow all instructions and safety messages in this manual.

SAVE THESE INSTRUCTIONS

Safety Message Types

The following messaging is used to identify a hazard to equipment or personnel:



DANGER

Indicates a hazardous situation which, if not avoided, will result in death or serious injury.



WARNING

Indicates a hazardous situation which, if not avoided, could result in death or serious injury.



CAUTION

Indicates a hazardous situation which, if not avoided, could result in minor or moderate injury.

NOTICE

Indicates information considered important but not hazard, or personal injury, related - for example, property damage.

General Safety

Installation and maintenance should be performed only by qualified persons. Installers and maintenance personnel assume the risk of all injury that might occur during installation or maintenance including, without limitation, the risk of electric shock. Follow your safety procedures and protocols.

All electrical installations must be done in accordance with the local and National Electrical Code ANSI/NFPA 70; Canadian Electrical Code, Part I; or the applicable standards, codes, and regulations for your region.

Failure to follow this manual will void warranty.

The Ampt product contains no user-serviceable parts. All repairs and maintenance should be handled in accordance with the instructions and terms contained in the product warranty.

Before installing or using the Ampt optimizer, read all of the instructions and safety messages on the optimizer and in this manual. Follow the safety precautions for this product as well as the other components in the PV system.

PV modules produce electrical energy when exposed to light and thus can create an electrical shock hazard. Wiring of the PV modules should only be performed by qualified personnel.

NOTICE

Opening the optimizers, performing any other service to the optimizers, or using the optimizers in a way that is not specified by the manufacturer voids warranty.

Disclaimer of Liability

Ampt makes no representations, expressed or implied, that with respect to this documentation or any of the equipment and/or software it may describe, including (with no limitation) any implied warranties of utility, merchantability, or fitness for any particular purpose. All such warranties are expressly disclaimed. Ampt shall not be liable for any indirect, incidental, or consequential damages under any circumstances. (The exclusion of implied warranties may not apply in all cases under some statutes, and thus the above exclusion may not apply.)

The following information is subject to change without notice, even though every attempt has been made to make this document complete, accurate and up to date. Readers are cautioned, however, that Ampt reserves the right to make changes without notice and shall not be responsible for any damages, including indirect, incidental or consequential damages, caused by reliance on the material presented, including, but not limited to, omissions, typographical errors, arithmetical errors or listing errors in the content material.

WARNING

Any use of the Ampt String Optimizer that is not expressly authorized in this manual or associated documentation is expressly prohibited by Ampt. Ampt disclaims any responsibility or liability for such prohibited use.

Optimizers Covered in this Manual

This manual applies to the i13.5 String Optimizer, which includes all applicable system voltages as well as any valid combination of open-circuit output voltage and maximum output current options.

The i13.5 String Optimizer replaces the legacy naming conventions listed below.

Vxxx-13.5-xx
V1300-13.5-12.8, V1300-13.5-12
V1000-13.5, V1000-13.5-13.5, V1000-13.5-12.8, V1000-13.5-12
V750-13.5, V750-13.5-13.5, V750-13.5-12.8, V750-13.5-12
V600-13.5, V600-13.5-13.5, V600-13.5-12.8

About Optimizer Models (SKUs)

Optimizer models use the format below:

Vxxx-iy-zz

Where, xxx = Open-circuit output voltage option
iy = String Optimizer name
zz = Maximum output current option

For example, V950-i13.5-12.8 is an i13.5 String Optimizer with an open-circuit output voltage of 950 volts and a maximum output current of 12.8 amps. The specifications for this unit can be found in the i13.5 datasheet for 1000-volt systems.

Before You Begin

Handling and Storage

- Store optimizers in a clean, dry area that is protected from weather exposure and pooling water (-30 to 80°C. Relative humidity < 80%).

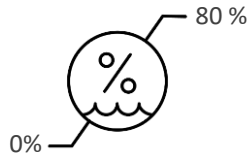
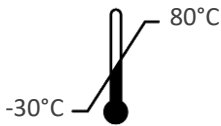

- Leave the product in its original packing box until you are ready to install.
- Do NOT stack pallets.
- Do NOT lift, carry, or otherwise handle the optimizers by their connectors.

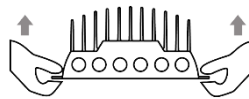
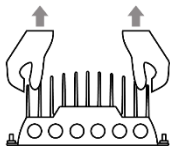
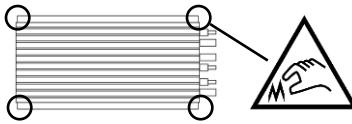
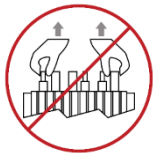

- Leave connector caps in place until the optimizers are ready to be connected to protect the optimizer from water and debris ingress.
- Do NOT transport optimizers that are removed from original packaging. If the original packaging is no longer available, use a similar box to protect the connectors and heat sink fins.

Quick Reference and Best Practices

NOTICE

The last page of this manual has a quick reference sheet for making electrical connections as well as a list of best practices. *After reading this manual*, the quick reference sheet can be used on the job site to ensure the correct electrical connection order and to avoid damaging the device.

Using Optional Wireless Communication

NOTICE

If the String Optimizers are being used with optional wireless communication, then refer to the Ampt Communication Unit (Ampt CU) manual for important requirements related to the String Optimizer installation.

Table of Contents

Read This First	3
Important Safety Instructions	4
Safety Message Types	4
General Safety	5
Disclaimer of Liability	6
Optimizers Covered in this Manual	7
About Optimizer Models (SKUs)	7
Before You Begin	8
Handling and Storage	8
Quick Reference and Best Practices	8
Using Optional Wireless Communication	8
Chapter 1: Product Overview	13
Dimensional Drawings	14
Physical Overview	15
Bar Code Label	15
Specifications.....	16
Chapter 2: Understanding Electrical Configurations.....	17
PV Array Configurations	17
Ungrounded PV Arrays.....	17
Grounded PV Arrays (positive or negative).....	17
Input Criteria	18
Acceptable Input Configurations.....	18
Unacceptable Input Configurations	18
Acceptable Input Configurations Between Parallel Optimizers	19
Fuses	19
DC-coupled Storage	19
Inter-row Shading Wiring Example	20
Chapter 3: Installing the String Optimizer.....	21
Getting Started	21
Parts and Tools Needed	21
Mounting and Grounding the String Optimizer	22
Mounting Considerations.....	22
Steps.....	23
Understanding Connector Polarity.....	24
Making Electrical Connections	25

Connection/Disconnection Order Matters	26
Connecting the Inputs	26
Connecting the Output	29
Disconnecting the Output and Inputs	30
Parts and Tools Needed	30
Steps.....	31
Appendix.....	33
Compliance.....	33
Model Numbering System	33
Markings.....	33
FCC Compliance.....	34
RSS-GEN	34
Avis IC.....	35
RSS-GEN	35
Reference: Electrical Connection Order.....	37
Handling and Storage Best Practices.....	38
Mounting Best Practices	38
Electrical Connections Best Practices.....	38
Ampt Support Contacts.....	38

Chapter 1: Product Overview

Ampt String Optimizers are DC/DC converters with multiple features that lower the cost and improve the performance of new and existing PV systems and energy storage systems.

- **Dual MPPT per optimizer** - Ampt String Optimizers put maximum power point tracking on each of its two input strings of PV modules. This mitigates or eliminates mismatch losses to deliver more energy under changing environmental and system conditions over the lifetime of the power plant.
- **High Fixed-Voltage Bus (HFVB)** – Ampt’s advanced DC power management technology allows for HFVB system designs which turn the variable voltage of the PV array into a fixed and predictable DC bus voltage to achieve system-level economic advantages.
- **Ampt Mode[®]** – Inverters in Ampt Mode[®] operate in a fixed or narrow input voltage range that is closer to the maximum system voltage. This allows the inverter to deliver a higher AC output voltage at the same current which raises the inverter’s rated output power up to 50% to lower the inverter’s cost per watt.
- **String Stretch[®]** – Ampt’s patented String Stretch[®] technology puts voltage and current limits on the output of each optimizer which doubles the number of modules per string and allows for smaller conductor sizing per kilowatt delivered to save up to 25% on electrical BOS costs.
- **Direct-to-Converter** – For DC-coupled energy storage systems with Ampt, the DC bus operates at a fixed voltage that is always higher than the battery voltage which eliminates 50% of the battery converters’ power circuitry while increasing its power density to lower the converter’s cost per watt.
- **High DC/AC** – This Ampt feature allows PV system designers to achieve optimal DC:AC ratios (up to 3:1); expand the DC power on existing systems without replacing inverters, combiners, or cables; optimize inverter utilization; and increase storage durations – all at a lower capex.
- **V-match[®]** – The output of our optimizers matches the DC bus voltage set by the inverter or battery converter while delivering full available power from the PV modules. This uniquely allows PV arrays with Ampt to automatically adapt to legacy or future power equipment to repower existing systems, upgrade inverters, mix new and legacy PV modules, deploy optimized DC-coupled storage systems, and other applications.
- **Full Tracker Fit** – Ampt optimizers overcome string-voltage sizing constraints to fit more modules on a tracker than systems without Ampt. Increasing the number of modules per tracker allows system designers to fully use the tracker’s mechanical capacity and lower tracker cost per watt.
- **Wireless Communication** – Ampt String Optimizers incorporate optional wireless communication to provide string-level data that is highly accurate, synchronous, and scalable to improve O&M, as well as enhanced controls for storage applications.

For more information on Ampt’s product features and applications, visit www.ampt.com.

Dimensional Drawings

The dimensions for the String Optimizer shown below are in millimeters and inches.

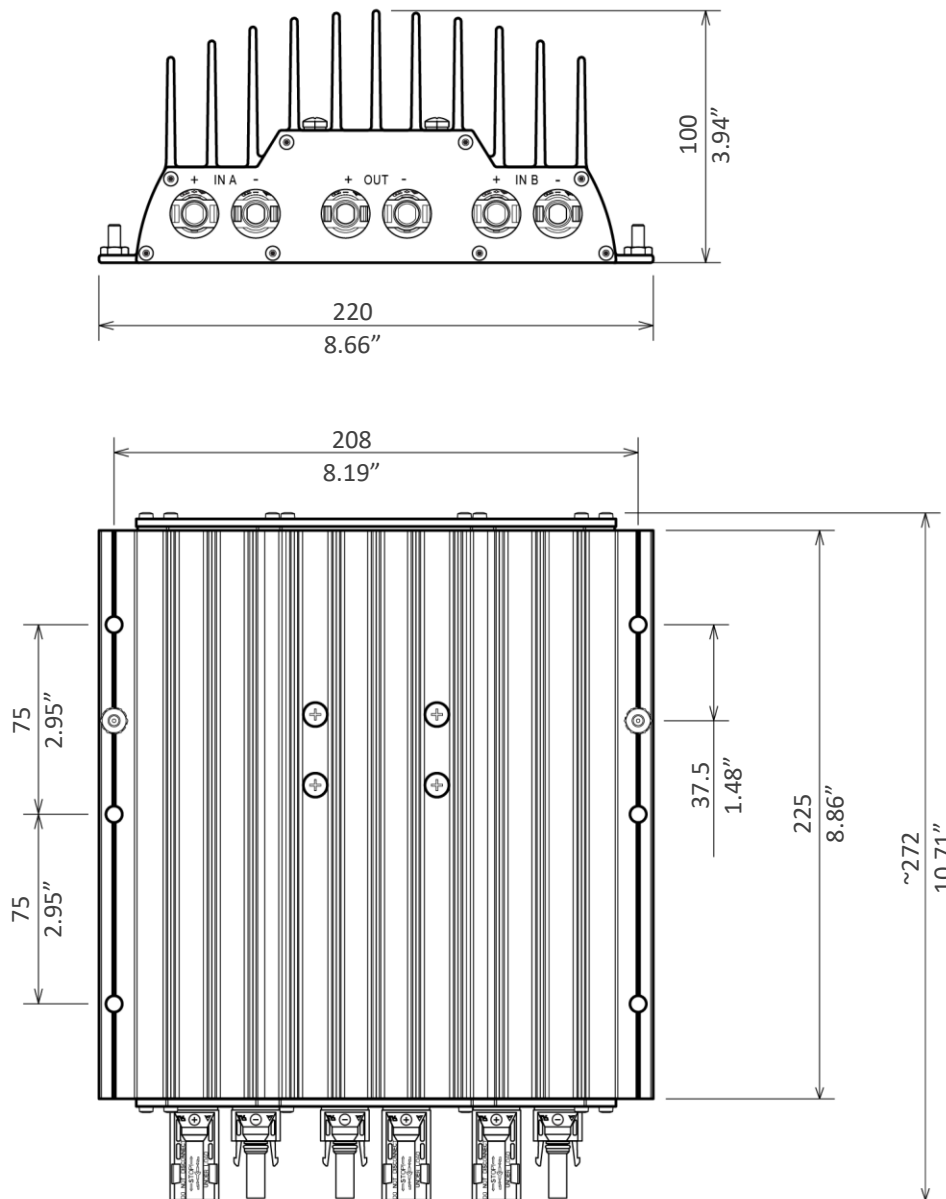

Figure 1: Dimensional drawings

Physical Overview

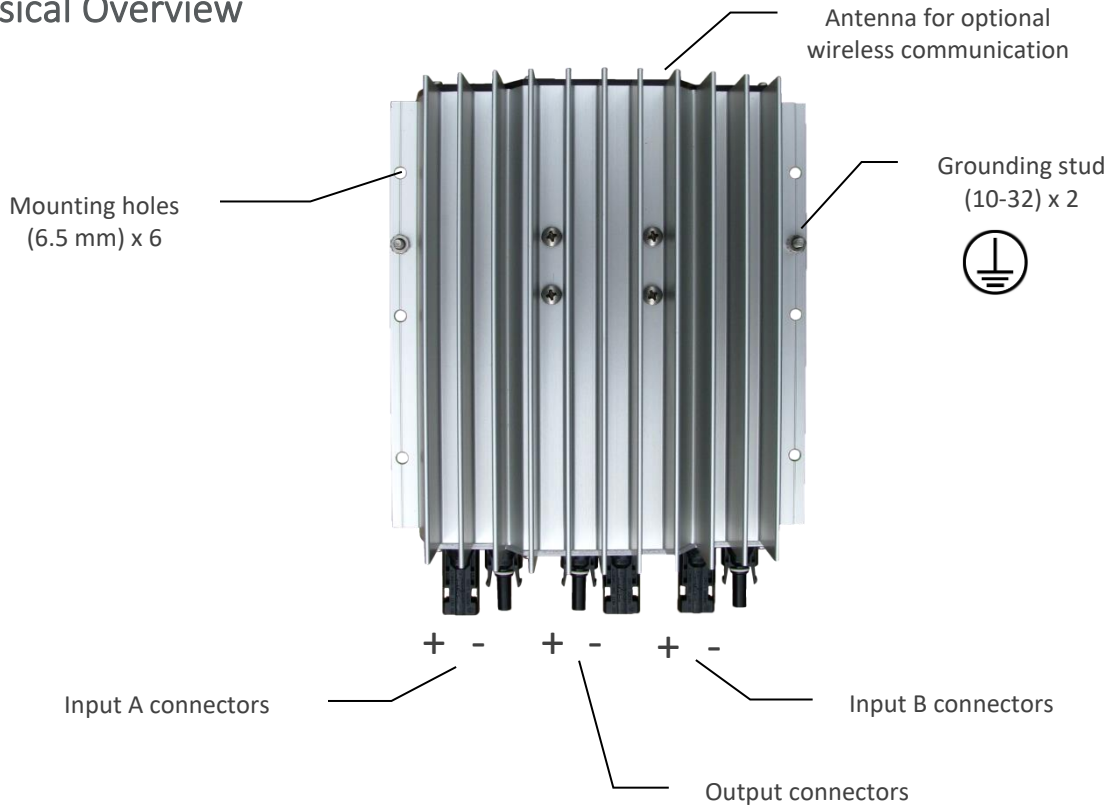

Figure 2: Physical overview of the string optimizer

Bar Code Label

The image below shows the bar code label with model and serial numbers. Do NOT remove this label. Removing any label from the optimizer voids warranty.



Figure 3: Bar code tag with the model and serial numbers

Specifications

The following specifications apply to all i13.5 String Optimizers. Electrical specifications vary by model and can be found on the optimizer product label and/or datasheet.

Mechanical	
Input & output connector	Amphenol H4
Dimensions	10.71" x 8.66" x 3.94" (272 mm x 220 mm x 100 mm)
Weight	9.0 lbs. (4.1 kg)
Ambient temperature operating range	-40 °F to +122 °F (-40 °C to +50 °C)
Cooling	Convection
Environmental	
Environmental category	Outdoor
Pollution degree	2
Maximum operating altitude	9843 ft (3000 m)
Overvoltage category	OVII
Ingress protection	IP66 / 4X
General	
Compliance	ETL to UL 1741; IEC 61000-6-1, 61000-6-3, 62109; CE; Giteki 2-1-19; FCC Part 15, class A

Chapter 2:

Understanding Electrical Configurations

This chapter explains the installation requirements and considerations that ensure proper operation of the String Optimizer.

NOTICE

The inputs of the optimizer are not intended for connection to a battery or any other type of DC source except PV modules.

PV Array Configurations

String Optimizers can be installed in ungrounded and resistively grounded PV systems.

Ungrounded PV Arrays

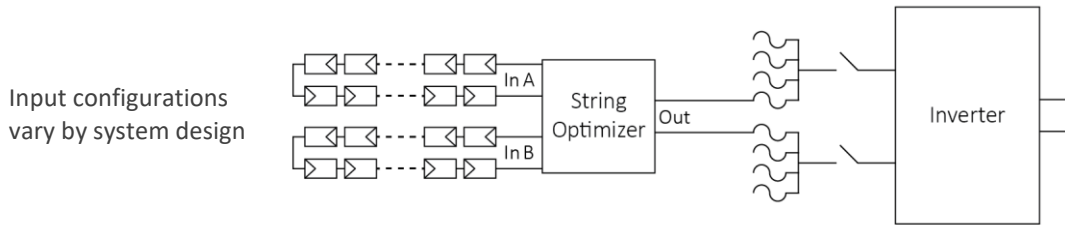

Figure 4: Electrical connections for an ungrounded PV array

Grounded PV Arrays (positive or negative)

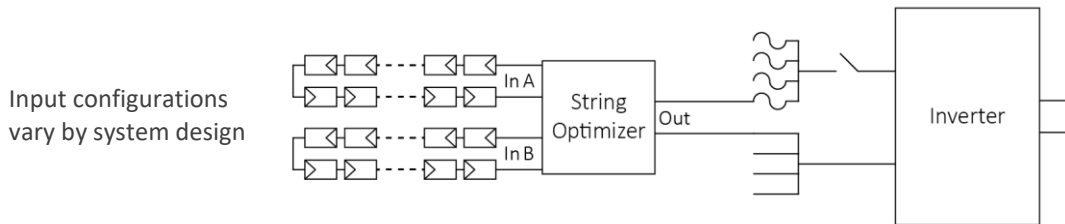

Figure 5: Electrical connections for a grounded PV array

Input Criteria

In the figures that follow, the number of modules connected in series is representative only. Follow Ampt's design guidelines to determine the number of modules for each input.

Acceptable Input Configurations

It is common for inputs A and B to have the same number of modules (i.e. $A = B$). However, if the number of modules between inputs is different, then input A can have one more module than input B (i.e. $A = B + 1$).

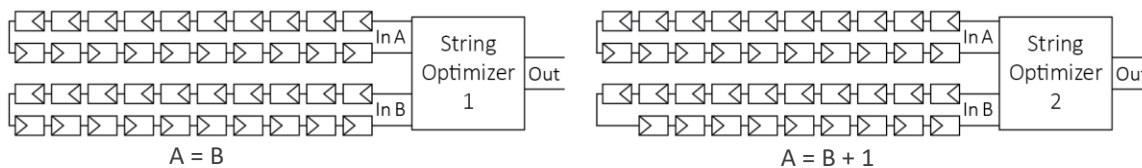

Figure 6: The number of modules on each input can be the same as illustrated by String Optimizer 1, or input A can have one more module than input B as shown by String Optimizer 2.

Unacceptable Input Configurations

The figure below illustrates input configurations that do not meet the criteria described in the previous section.

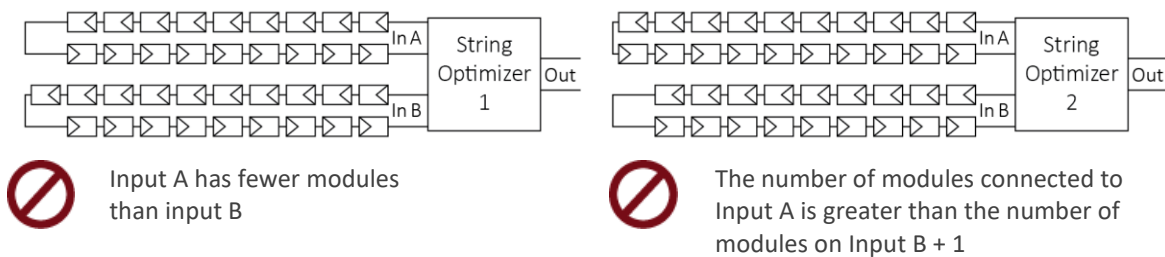

Figure 7: Unacceptable input configurations.

Acceptable Input Configurations Between Parallel Optimizers

The number of modules on each input between parallel optimizers can vary within an array so long as they meet the criteria described in the *Acceptable Input Configurations* section and are within the minimum and maximum limits determined by Ampt’s design guidelines. An example is shown below.

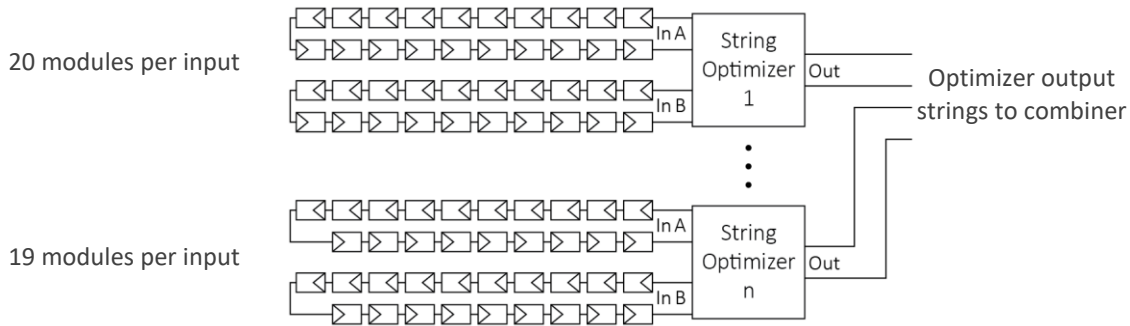

Figure 8: The number of modules per input between parallel optimizers can vary so long as they follow the acceptable input configuration criteria and Ampt’s design guidelines.

Fuses

CAUTION

Over-current protection devices and conductors shall be sized in accordance with the National Electrical Code (ANSI/NFPA 70); Canadian Electrical Code, Part I; or the applicable standards, codes, and regulations for your region.

The output current limit of the Ampt String Optimizer eliminates the need for the 1.25 multiplication factor for over-sun conditions when calculating ampacity. The 1.25 multiplier for continuous use is still required.

Optimizer Max Output Current (A)	Minimum Fuse Size (A)
12	15
12.8	16
13.5	16.875

DC-coupled Storage

When used in DC-coupled storage applications, the optimizer does not function as a blocking diode.

Inter-row Shading Wiring Example

When inter-row shading is expected, the best practice is to wire the modules on the two inputs of the Ampt String Optimizer to be on the same row as shown below.

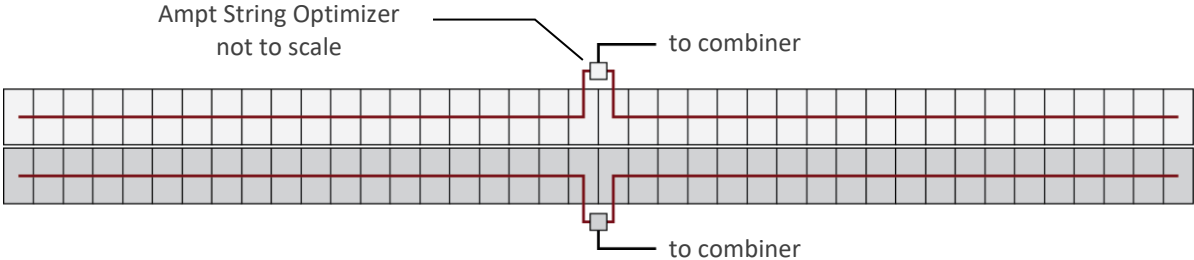

Figure 9: Wiring example when inter-row shading is expected

Chapter 3: Installing the String Optimizer

Getting Started

This chapter addresses the proper mounting and installation of the Ampt String Optimizer. Read the entire chapter before starting the procedures and then conduct each task in the order given.

Parts and Tools Needed

- The mounting hardware varies by the type of PV module mounting rail.
- Voltmeter (rated for the PV system’s maximum system voltage) with DC current clamp.
- Amphenol Sealing Caps - Amphenol p/n: UTXPF (female), UTXPM (male)



H4 Sealing Cap (for female)
H4PF



UTX Sealing Cap (for female)
UTXF



H4 Sealing Cap (for male)
H4PM



UTX Sealing Cap (for male)
UTXM

Mounting and Grounding the String Optimizer

Mounting Considerations

- Do NOT mount optimizers with connectors facing upwards.
- Leave space between mounted optimizers to allow for air circulation and cooling.
- Ensure sufficient spacing so that maintenance personnel can read the optimizer faceplate, safety icons, serial number, model number, and bar code label.
- Keep optimizer free from pooling water.
- Do NOT mount optimizers directly to a solar module frame.
- Do NOT drill into optimizer frame to expand mounting holes.
- Secure the optimizer by using at least two of the 6.5 mm mounting holes.
- If using wireless communication:
 - Optimizers have an antenna on the opposite side of the connectors. Keep the antenna clear from obstructions - including cables, mounting hardware, and PV modules, to allow radio waves to and from the Ampt Communication Unit (CU).
 - Line of sight from the optimizer to the Ampt CU is recommended.
 - See the [Ampt CU manual](#) for more information.
- When possible, mount optimizer in a location protected from the elements.
- Leave connector sealing caps in place until the optimizers are ready to be connected to the PV string.

WARNING

Read the warning statements below:

Installation and maintenance should be performed only by qualified persons. Installers and maintenance personnel assume the risk of all injury that might occur during installation or maintenance including, without limitation, the risk of electric shock. Follow your safety procedures and protocols.

All electrical installations must be done in accordance with the local and National Electrical Code ANSI/NFPA 70; Canadian Electrical Code, Part I; or the applicable standards, codes, and regulations for your region.

The Ampt optimizer is to be installed so that it is not expected to be contacted by persons.

CAUTION

Keep connectors dry and clean. Do not install Ampt String Optimizers in a location where they might be immersed in water.

NOTICE

Read the notice statements below:

Leave the product in its original packing box until you are ready to install.

Leave connector sealing caps in place until the optimizers are ready to be connected to the PV string. The plugs protect the optimizer from water and debris ingress.

Do NOT lift, carry, or otherwise handle the optimizers by their connectors.

Do NOT transport optimizers that are removed from packaging. If the original packaging is no longer available, use a similar box to protect the connectors and heat sink fins.

Steps

1. Read all warning, caution, and notice statements for this section.
2. Mount the String Optimizer following the [Mounting Considerations](#) section.
3. Ground the String Optimizer according to your local codes. Use one of the two grounding studs provided on the optimizer, a listed bonding washer, or another method as required. Optimizer coating is 4 mil (0.1 mm).
4. Verify that the optimizer is adequately grounded using continuity tester.

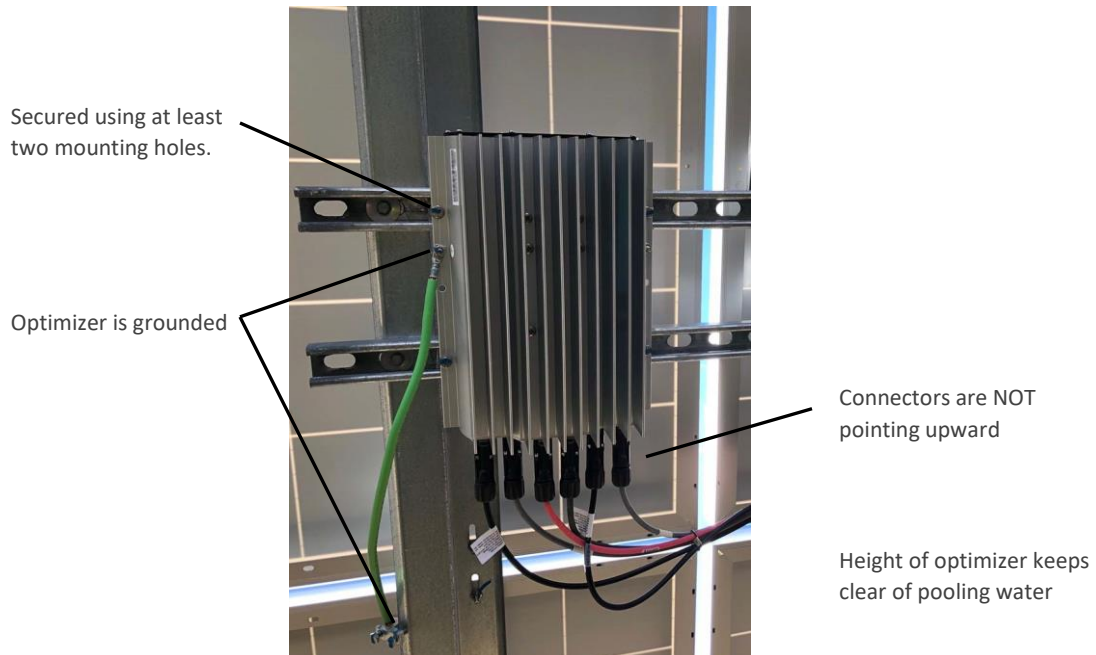

Figure 10: Ampt String Optimizer mounted and grounded

Understanding Connector Polarity

Always use the polarity markings on the faceplate instead of the polarity markings on the connectors.

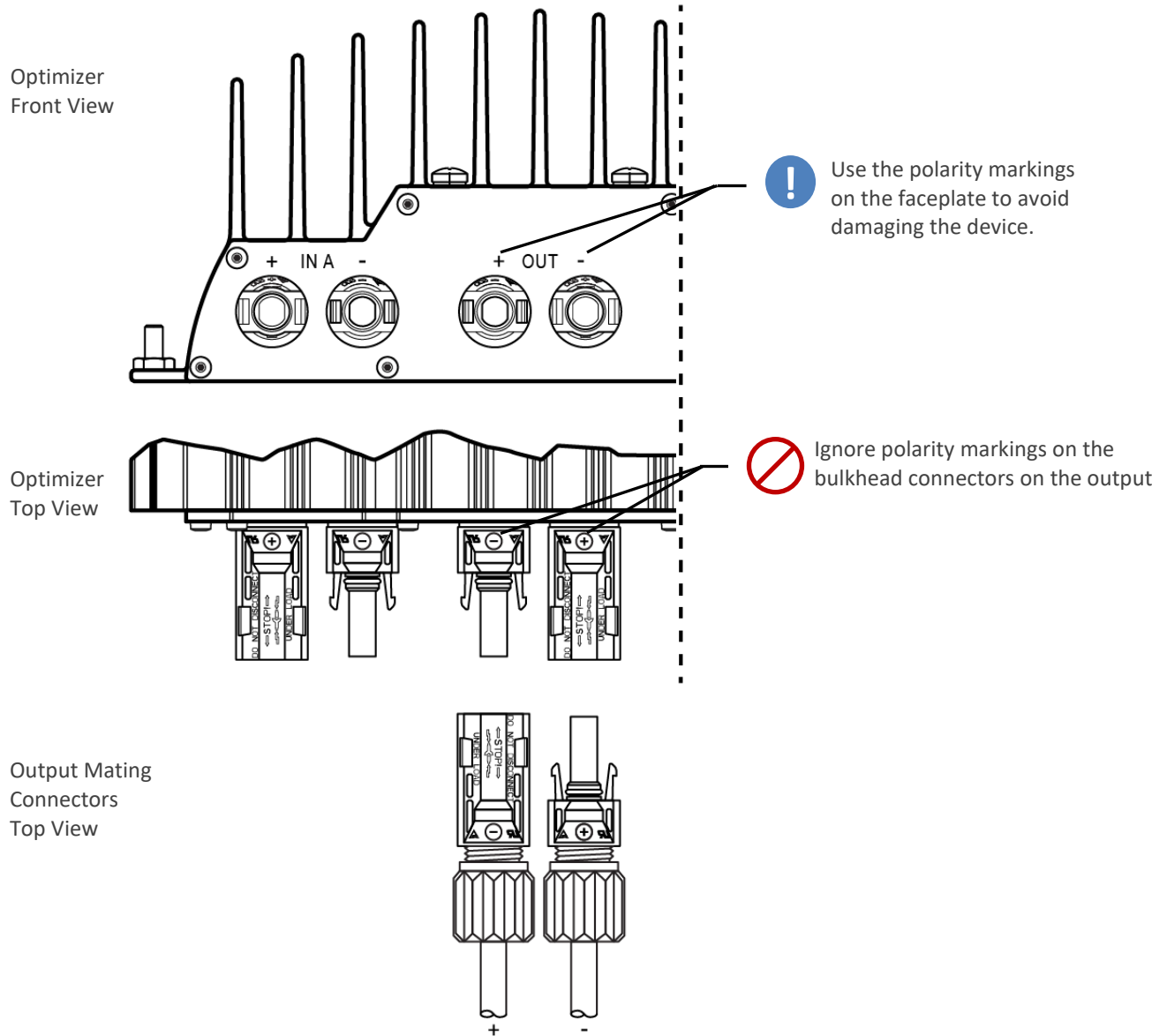

Figure 11: Output connector polarity

Making Electrical Connections

WARNING

Read the warning statements below:

Installation and maintenance should be performed only by qualified persons. Installers and maintenance personnel assume the risk of all injury that might occur during installation or maintenance including, without limitation, the risk of electric shock. Follow your safety procedures and protocols.

Do not make or break connections under load.

Ensure that there are no parallel connections to the string while series connections are being made.

Voltage may be present on the output terminals when an input terminal is connected.

Voltage builds as modules are connected in series.

CAUTION

Read the caution statements below:

To reduce the risk of fire, connect the outputs of the Ampt equipment only to conductors with sufficient ampacity based on the maximum output fault current (maximum optimizer output current) for the chosen optimizer. Over-current protection devices and conductors shall be sized in accordance with the National Electrical Code (ANSI/NFPA 70); Canadian Electrical Code, Part I; or the applicable standards, codes, and regulations for your region.

Over current protection is required for the DC output circuit in the installation.

Ampt recommends that a disconnect switch be included in the installation for the DC output.

Do not put stress on the optimizer connectors at any time. The cable management method must prevent tension on each connector and movement of the connecting wires at all times. Tracker installations must avoid tension on the connectors throughout its rotation.

NOTICE

Read the notice statements below:

Failure to follow these instructions will void warranty.

Failure to follow the prescribed connection and disconnection order can result in damage to the device.

Follow these instructions to avoid damaging the device. Follow polarity markings on the optimizer faceplate. Do not cross-wire inputs or output.

Use only Amphenol H4 mating connectors.

Per Canadian Electrical Code, the installer is required to mark the device with the following wording or equivalent, located on or adjacent to each wiring compartment giving access to high voltage circuits, only if actually connected to high voltage in the installation:

DANGER — HIGH VOLTAGE
or
DANGER XXX V
where XXX is replaced by the rated voltage.

Connection/Disconnection Order Matters

Follow the proper connection/disconnection order in the instructions to avoid damaging the device.

Connecting the Inputs

1. Read all warning, caution, and notice statements for this section.
2. Make sure that the unit is properly mounted and grounded.
3. Make sure the strings of PV modules that will be connected to the inputs of the optimizer meet the acceptable input criteria, fusing, and other requirements outlined in Chapter 2.
4. Follow your safety procedures and protocols to connect the PV modules in series for each input.
5. Follow your safety procedures and protocols and use an appropriately rated multimeter to measure the voltage and verify the polarity for the string(s) of modules being connected to Input B.

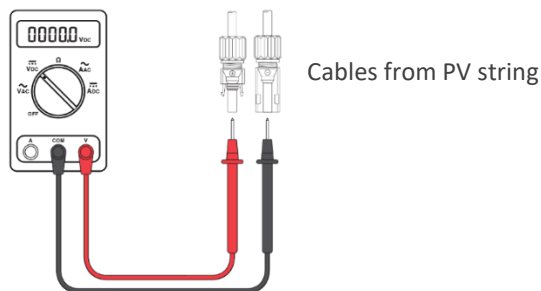

Figure 12: Check the polarity and gender for the PV string connecting to the Input

6. Connect the series of modules for Input B to the String Optimizer. Ensure that the locking mechanisms on the connectors are fully engaged.

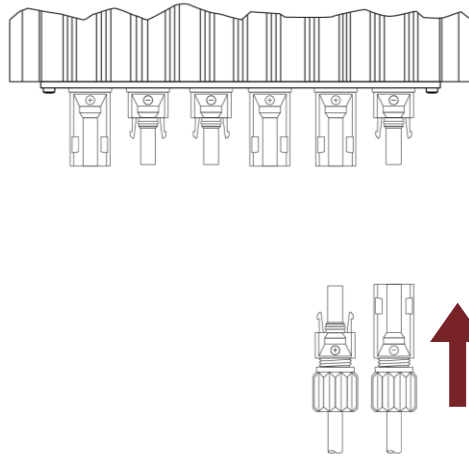

Figure 13: Connecting Input B

7. Follow your procedures and safety protocols to measure the voltage and verify the polarity for the string of modules being connected to Input A. See [Figure 12](#).
8. Connect the series of modules for Input A to the String Optimizer. Ensure that the locking mechanisms on the connectors are fully engaged.

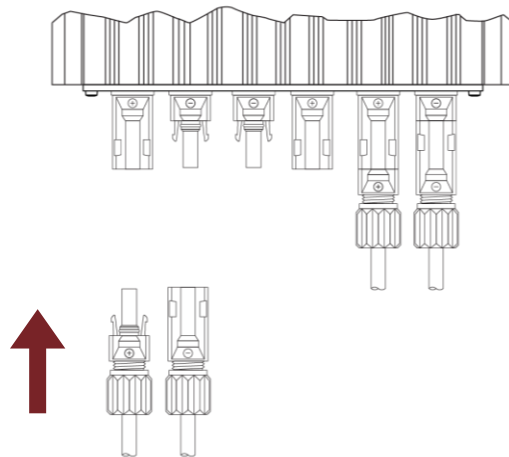

Figure 14: Connecting Input A

- Follow your safety procedures and protocols to measure the output voltage of the String Optimizer. It should be equal to the maximum value of the Output Voltage Range on the product label (+/- 15 volts). If it is not, replace the unit.

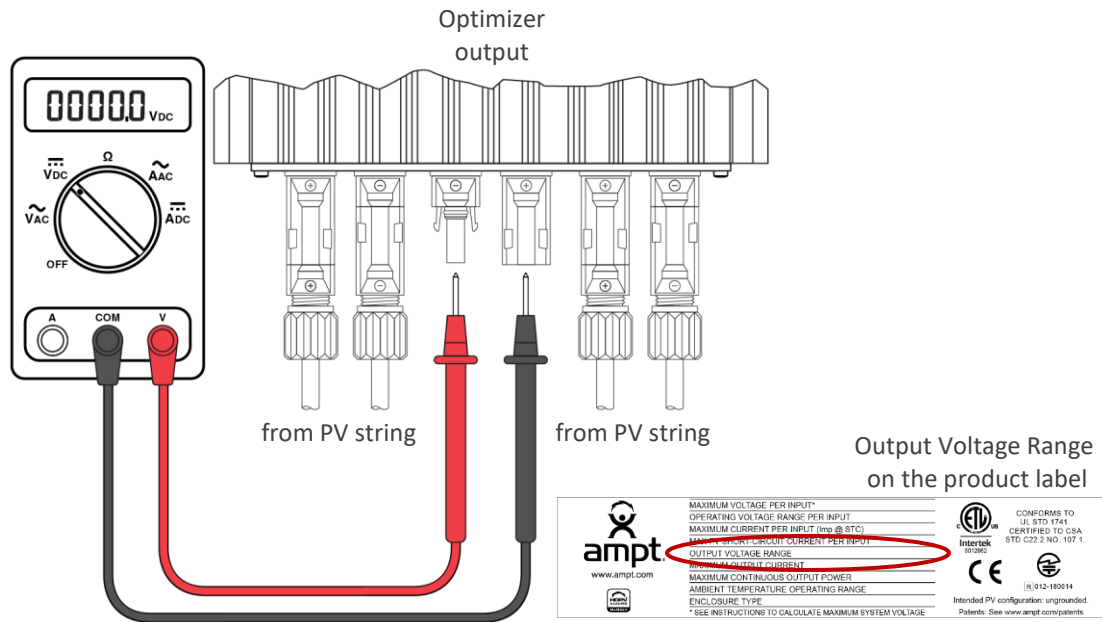

Figure 15: Verify proper installation

- If you are connecting the output now, then proceed to the next section. Otherwise, use sealing caps to protect the connectors until the output is connected.

Connecting the Output

1. Read all warning, caution, and notice statements for this section.
2. Make sure you have completed all the steps in the [Connecting the Inputs](#) section.
3. Follow your safety procedures and protocols to ensure the output cables are appropriately terminated and not under load.
4. If the output cable is already energized (not isolated), verify that the optimizer output voltage and output cable share the same potential and polarity.
5. Connect the appropriate cables to the output of the String Optimizer.

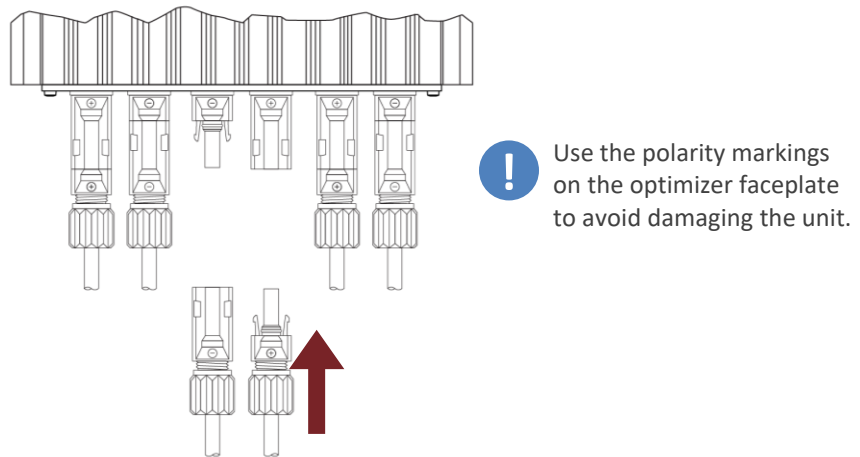

Figure 16: Connecting the output connectors

6. Ensure that the locking mechanisms on all connectors are fully engaged.
7. Manage wires to prevent lateral strain on connectors and avoid movement of the connecting wires at all times. Pay special attention when in-line fuses are used and/or when mounted on a tracker.

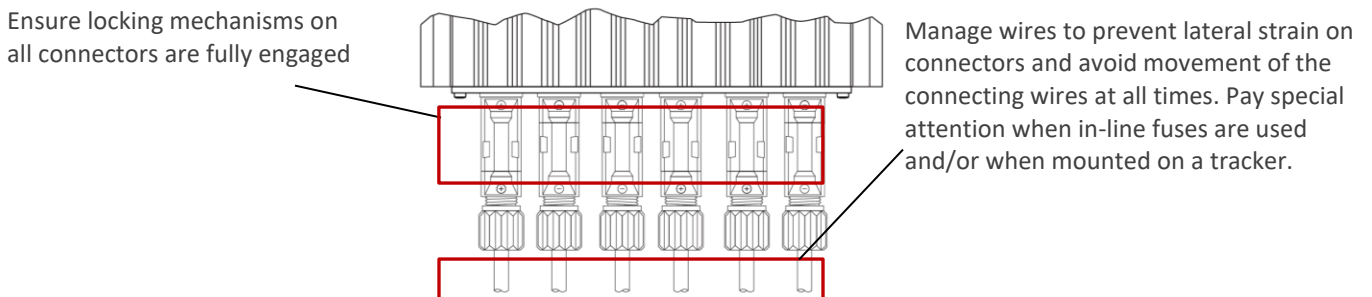

Figure 17: Verify that the connectors are fully engaged and manage cables to prevent tension on the connectors

Disconnecting the Output and Inputs

WARNING

Read the warning statements below:

Installation and maintenance should be performed only by qualified persons. Installers and maintenance personnel assume the risk of all injury that might occur during installation or maintenance including, without limitation, the risk of electric shock. Follow your safety procedures and protocols.

Do not perform any servicing other than that specified in these instructions.

Do not make or break connections under load.

Voltage may be present on the output terminals when an input terminal is connected.

CAUTION

Read that caution statements below:

The Ampt product contains no user-serviceable parts. All repairs and maintenance should be handled in accordance with the instructions and terms contained in the product warranty.

The surface of the optimizer may be hot.

NOTICE

Read the notice statements below:

Failure to follow these instructions will void warranty.

Failure to follow the prescribed order can result in damage to the device.

Parts and Tools Needed

- Appropriately rated voltmeter and DC current clamp
- Amphenol sealing caps for H4 or UTX connectors
- One of the following Amphenol connector unlocking tools:



H4 Universal unlocking tool
H4TU0000



H4 Wrench Tool
H4TW0001



UTX Wrench Tool
UTXTWA001

Steps

1. Read all warning, caution, and notice statements for this section.
2. Follow your safety procedures and protocols to ensure the String Optimizer is not under load.
3. Follow your safety procedures and protocols to verify that there is zero current flowing through the optimizer circuit by using a current clamp to test each wire connected to Input A, Input B, and the Output.
 - a. If current is detected on any of these cables, wait for zero irradiance and verify that there is zero current flowing through the optimizer circuit.

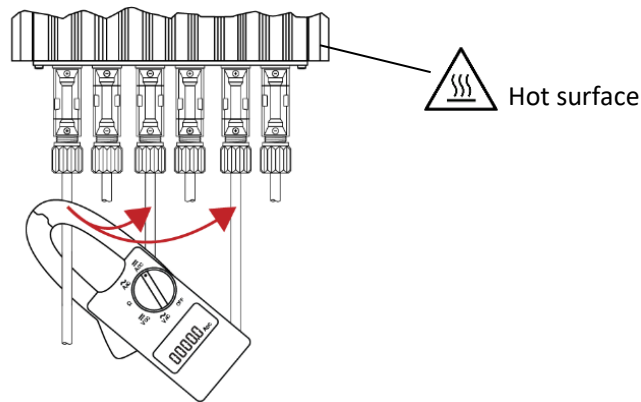

Figure 18: Verify that there is zero current flowing through the optimizer circuit

4. If no current is detected, then use the Amphenol H4 connector unlocking tool to disconnect connectors in the following order:

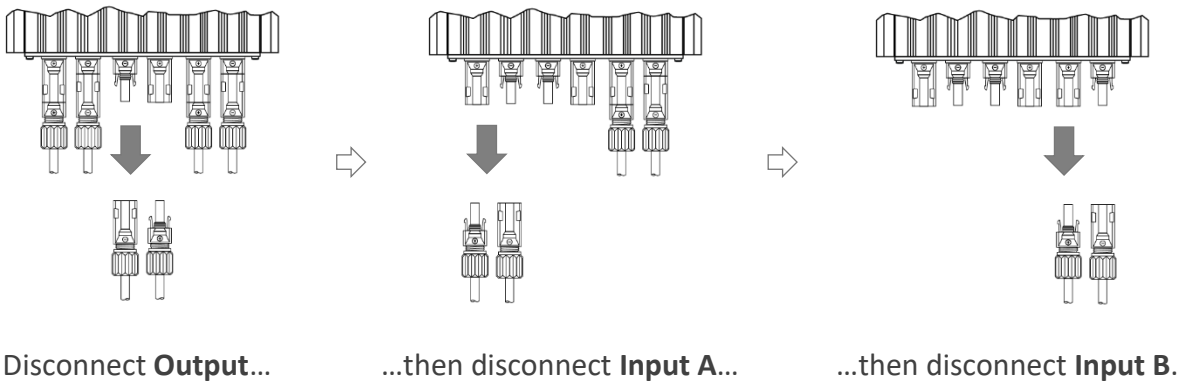

Figure 19: Disconnection order matters

5. If the PV cables will not be immediately reconnected, use sealing caps on the optimizer connectors to protect the unit from water and debris ingress.

Appendix

Compliance

The box is not meant to be user serviced or opened in any way.





Model Numbering System

The model numbers for Ampt String Optimizers are in the following format:

- 31570017-xxxx (13.5A models, ranging from 350 – 1300V)
- 31570015-xxxx (12.8A models, ranging from 350 – 1300V)
- 31570014-xxxx (12A models, ranging from 350 – 1300V)

...where xxxx equals voltage of the unit (e.g. -0750 is a V750; -0975 is a V975).

Markings

 www.ampt.com 	MAXIMUM VOLTAGE PER INPUT*
	OPERATING VOLTAGE RANGE PER INPUT
	MAXIMUM CURRENT PER INPUT (I_{mp} @ STC)
	MAX PV SHORT-CIRCUIT CURRENT PER INPUT
	OUTPUT VOLTAGE RANGE
	MAXIMUM OUTPUT CURRENT
	MAXIMUM CONTINUOUS OUTPUT POWER
	MAXIMUM AMBIENT TEMPERATURE
	ENCLOSURE TYPE
	* SEE INSTRUCTIONS TO CALCULATE MAXIMUM SYSTEM VOLTAGE
 5012862	CONFORMS TO UL STD 1741. CERTIFIED TO CSA STD C22.2 NO. 107.1.
	
Intended PV configuration: ungrounded. Patents: See www.ampt.com/patents	

FCC Compliance

This device complies with part 15 of the FCC Rules. Operation is subject to the following two conditions: (1) This device may not cause harmful interference, and (2) this device must accept any interference received, including interference that may cause undesired operation.

This equipment complies with radiation exposure limits set forth for uncontrolled environment. The antenna(s) used for this transmitter must be installed to provide a separation distance of at least 20 cm from all persons.

IMPORTANT! Changes or modifications not expressly approved by Ampt, LLC could void the user's authority to operate the equipment.

NOTE: This equipment has been tested and found to comply with the limits for a Class A digital device, pursuant to part 15 of the FCC Rules. These limits are designed to provide reasonable protection against harmful interference when the equipment is operated in a commercial environment. This equipment generates, uses, and can radiate radio frequency energy and, if not installed and used in accordance with the instruction manual, may cause harmful interference to radio communications. Operation of this equipment in a residential area is likely to cause harmful interference in which case the user will be required to correct the interference at his own expense.

FCC ID # X3R-31570014
Model Number: 31570014
IC: 8399A-31570014

RSS-GEN

This device contains license-exempt transmitter(s)/receiver(s) that comply with Innovation, Science and Economic Development Canada's license-exempt RSS(s). Operation is subject to the following two conditions:

1. This device may not cause interference.
2. This device must accept any interference, including interference that may cause undesired operation of the device.

Avis IC

Cet appareil est conforme à la partie 15 des règles de la FCC. Son fonctionnement est soumis aux deux conditions suivantes: (1) Ce dispositif ne peut causer des interférences nuisibles, et (2) cet appareil doit accepter toute interférence reçue, y compris les interférences qui peuvent provoquer un fonctionnement indésirable.

Cet équipement est conforme aux limites d'exposition aux rayonnements définies pour un environnement non contrôlé. L'antenne (s) utilisé pour cet émetteur doit être installé pour fournir une distance de séparation d'au moins 20 cm de toute personne.

IMPORTANT! Les changements ou modifications non expressément approuvés par Ampt, LLC pourraient annuler l'autorité de l'utilisateur à utiliser l'équipement.

Remarque: Cet équipement a été testé et trouvé conforme aux limites de la classe A des appareils numériques, conformément à la partie 15 des règles de la FCC. Ces limites sont conçues pour fournir une protection raisonnable contre les interférences nuisibles lorsque l'équipement est utilisé dans un environnement commercial. Cet équipement génère, utilise et peut émettre de l'énergie radiofréquence et, si non installé et utilisé conformément au manuel d'instruction, peut causer des interférences nuisibles aux communications radio. Le fonctionnement de cet équipement dans une zone résidentielle est susceptible de provoquer des interférences nuisibles, auquel cas l'utilisateur sera tenu de corriger les interférences à ses propres frais.

FCC ID # X3R-31570014
Model Number: 31570014
IC: 8399A-31570014

RSS-GEN

L'émetteur/récepteur exempt de licence contenu dans le présent appareil est conforme aux CNR d'Innovation, Sciences et Développement économique Canada applicables aux appareils radio exempts de licence. L'exploitation est autorisée aux deux conditions suivantes:

1. L'appareil ne doit pas produire de brouillage.
2. L'appareil doit accepter tout brouillage radioélectrique subi, même si le brouillage est susceptible d'en compromettre le fonctionnement.

Reference: Electrical Connection Order

After the installer has read the manual, this page can be used as a reference on the job site to ensure the electrical connection order and to avoid damage to the device.



These instructions are for reference only and do not replace the installation manual. See the manual for complete instructions and safety messages.



WARNING

Read the warning statements below:

Installation and maintenance should be performed only by qualified persons. Installers and maintenance personnel assume the risk of all injury that might occur during installation or maintenance including, without limitation, the risk of electric shock. Follow your safety procedures and protocols.

Do not make or break connections under load.

Ensure that there are no parallel connections to the string while series connections are being made.

Voltage may be present on the output terminals when an input terminal is connected.

Voltage builds as modules are connected in series.

Do not put lateral strain on the optimizer connectors at any time. The cable management method must prevent strain on each connector and movement of the connecting wires at all times. Tracker installations must avoid tension on the connectors throughout its rotation.

NOTICE

Failure to follow these instructions will void warranty.

Failure to follow the prescribed connection order can result in damage to the device.

1. Verify PV string voltage and polarity. Connect Input B

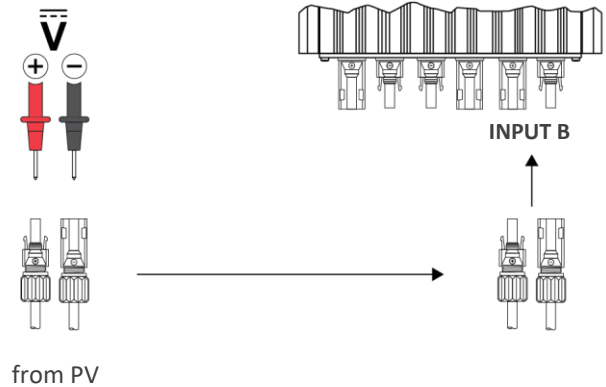

2. Verify PV string voltage and polarity. Connect Input A

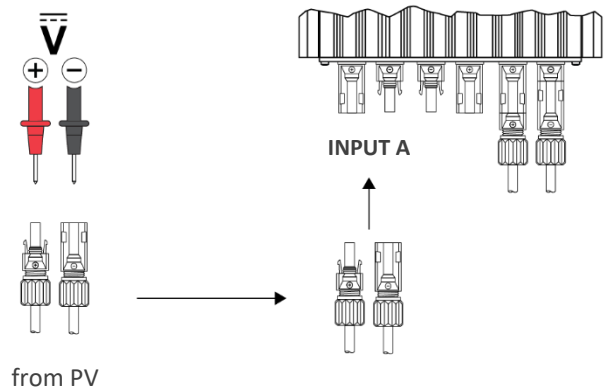

3. Verify output voltage. Connect Output

V_{out} = maximum value of the Output Voltage Range on the label (+/-15 volts)

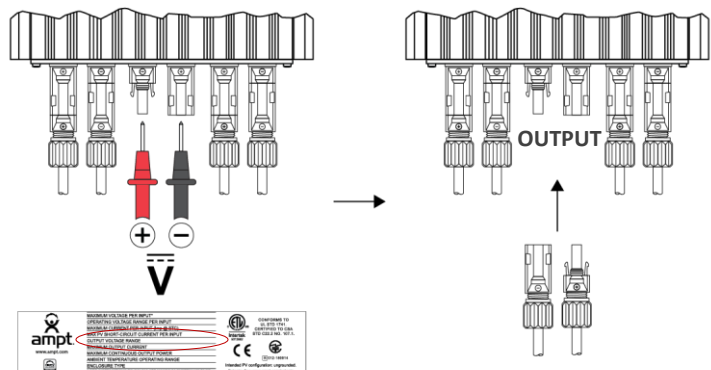

Use the polarity markings on the optimizer faceplate

Note: Disconnect in reverse order (Output, Input A, Input B) using an Amphenol connector unlocking tool for H4 connectors (e.g. Amphenol p/n: H4TU0000)

Handling and Storage Best Practices

- Store optimizers in a clean, dry area that is protected from weather exposure and pooling water (-30 to 80°C. Relative humidity < 80%).
- Leave the product in its original packing box until you are ready to install.
- Do NOT stack pallets.
- Do NOT lift, carry, or otherwise handle the optimizers by their connectors.
- Leave connector caps in place until the optimizers are ready to be connected to protect the optimizer from water and debris ingress.
- Do NOT transport optimizers that are removed from original packaging. If the original packaging is no longer available, use a similar box to protect the connectors and heat sink fins.

Mounting Best Practices

- Ground the String Optimizer according to your local codes.
- Verify that the optimizer is adequately grounded using continuity tester.
- Do NOT mount optimizers with connectors facing upwards.
- Leave space between mounted optimizers to allow for air circulation and cooling.
- Ensure sufficient spacing so that maintenance personnel can read the optimizer faceplate, safety icons, serial number, model number, and bar code label.
- Keep optimizer free from pooling water.
- Do NOT mount optimizers directly to a solar module frame.
- Do NOT drill into optimizer frame to expand mounting holes.
- Secure the optimizer by using at least two of the 6.5 mm mounting holes.
- When possible, mount optimizer in a location protected from the elements.
- If using wireless communication, keep the antenna (located on the opposite side of the connectors) clear from obstructions. Line of sight from the optimizer to the Ampt Communication Unit (CU) is recommended. See Ampt CU manual for more information.
- Leave connector sealing caps in place until the optimizers are ready to be connected to the PV string.

Electrical Connections Best Practices

- Use only Amphenol mating connectors on input and output wires that are connected to optimizer.
- Only use Amphenol H4 crimping pliers with the appropriate crimp range on cabling and connectors.
- Do NOT cause lateral strain on the optimizer bulkhead connectors. Make sure there is enough slack on the input and output wires to avoid strain. If installed on a tracker system, keep wires free from abrasion and leave enough slack in the wires to account for tracker movement.
- Test voltage and polarity of input strings and optimizer output before connecting.
- Ensure there are no ground faults on input strings.
- Do NOT operate optimizer with only one input.
- Connect in the following order: Input B, Input A, Output.
- If the output cable is already energized (not isolated), verify that the optimizer output voltage and output cable share the same potential and polarity.
- Configure inverter settings appropriately according to the project design.
- Do NOT disconnect under load.
- Always use a current clamp to ensure there is no current present before disconnecting outputs/inputs.
- Disconnect in reverse order (Output, Input A, Input B) using an Amphenol unlocking tool for H4 connectors. (e.g. Amphenol p/n: H4TU0000)

Ampt Support Contacts

Global	North America	Europe	Japan
support@ampt.com	+1 970.372.6951	+49 7456 20 88 42	+81.45.565.9977

